



# Catalogue Principal

## Sutures chirurgicales

# Centre d'Excellence Closure Technologies : un savoir-faire produits spécifique

## Une technologie de production de pointe

Notre Centre d'Excellence Closure Technologies est basé à Rubí (Espagne). Là, toutes les fonctions pertinentes telles que la recherche et le développement, la fabrication, le service qualité, le marketing stratégique et les affaires réglementaires sont réunies pour renforcer le développement des produits et pour mettre au point de nouveaux produits.



## Une stratégie centrée sur le client

Conséquence du regroupement sur un seul et même site de tous ces savoir-faire très spécialisés, nous sommes en mesure d'améliorer nos produits et nos processus, de mettre en œuvre les changements nécessaires et donc de nous adapter aux nouvelles exigences des clients.



## Une compétence en matière de sutures, d'implants de réparation de paroi et de biosurgicaux\*

Le centre de compétence de Rubí fabrique une gamme complète de sutures résorbables, non résorbables et microchirurgicales et d'implants de réparation de paroi. Les biosurgicaux\* sont fabriqués à Melsungen et à Tuttlingen en Allemagne.



## Distribution centralisée des produits

La distribution à l'international des sutures et produits spécialisés est gérée par notre entrepôt central de Rubí (Espagne).



\* Produits de biochirurgie

# Informations générales sur les sutures

---

Informations sur les conditionnements

---

Informations sur les aiguilles

---

# Informations sur les conditionnements

---

RacePack®

---

DDP-Direct Dispense Packaging

---

Code couleur permettant l'identification des sutures

---

Systèmes de codes-barres B. Braun

---

Accessoires B. Braun

---

B. Braun, la garantie d'un niveau de qualité élevé et constant

---



# RacePack®

Système de conditionnement des sutures par B. Braun

B. Braun possède une expertise en sutures de longue date et maîtrise l'utilisation des technologies de pointe. En associant cette expertise à son engagement en faveur de l'amélioration continue, B. Braun a mis au point son conditionnement de sutures, à travers des partenariats de long terme avec des équipes chirurgicales du monde entier. RacePack® est une nouvelle référence dans le conditionnement des sutures qui répond aux besoins de votre équipe chirurgicale.



RacePack® - système de conditionnement simplifié

- Accès direct aux sutures, gain de temps pour le personnel du bloc

RacePack® - réduction de l'effet mémoire

- Grâce à son bobinage en cercle

RacePack® - identification simple du produit





Étapes de la manipulation :



Ouverture de l'emballage extérieur non stérile  
 ■ Large zone de préhension



Transfert du RacePack® vers la zone stérile



Préhension de l'aiguille directement dans l'emballage avec le porte-aiguille  
 ■ Rabat arrière souple permettant une préhension plus aisée de l'aiguille



Extraction de la suture en tirant vers la droite

# DDP-Direct Dispense Packaging

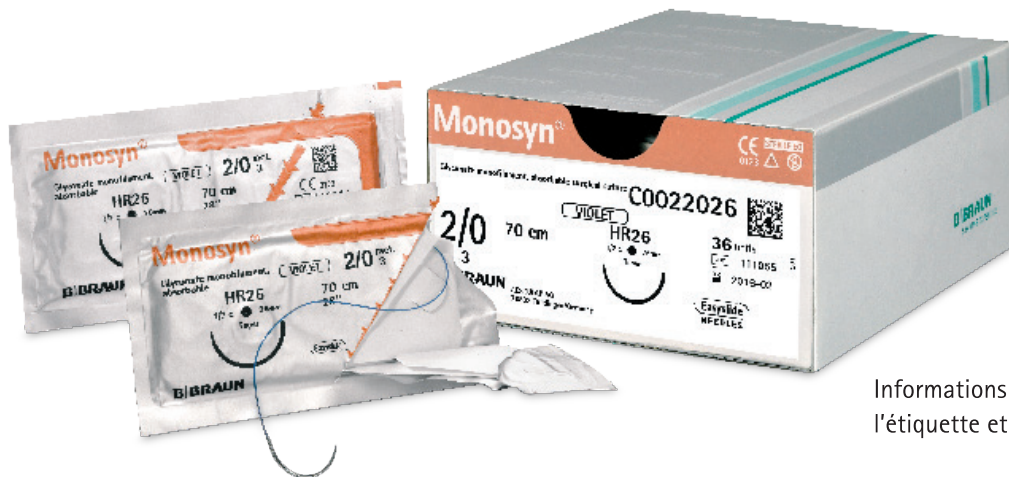

Informations produit figurant clairement sur l'étiquette et identification aisée des produits

## Étapes de la manipulation :



Ouverture de l'emballage extérieur non stérile



Transfert vers la zone stérile



Système d'ouverture à déchirer indiqué par des flèches de couleur









Préhension rapide et directe de l'aiguille  
Extraction de la suture en tirant vers la droite









# Code couleur permettant l'identification des sutures

## Sutures résorbables



 ■ Monosyn® Quick	 ■ Monosyn®	 ■ MonoPlus®	 ■ MonoMax®
 ■ Novosyn® Quick ■ Episio-Set	 ■ Novosyn® ■ Novosyn® CHD		

## Sutures non résorbables

 ■ Optilene®	 ■ Dafilon®	 ■ PremiCron®	 ■ Dagrofil®
 ■ Silkam®	 ■ Steelex® ■ Steelex® Electrode-Set ■ Steelex® Sternum-Set	 ■ Surgical Loop	

## Codage des articles permettant d'identifier le contenu des boîtes

Le code des sutures se compose d'1 lettre et 7 chiffres.  
La lettre indique le nombre d'unités dans chaque boîte :

	
M	Boîte de 6
G	Boîte de 12
B	Boîte de 24
C	Boîte de 36

# Systemes de codes-barres B. Braun

## Datamatrix

B. Braun imprime un code-barres Datamatrix (code 2D ou bidimensionnel) comportant des informations au format EAN-128 sur chaque conditionnement individuel et sur chaque boîte, garantissant ainsi l'identification unique du produit, avec notamment la date de péremption et le numéro de lot, et ce à tous les niveaux du conditionnement.

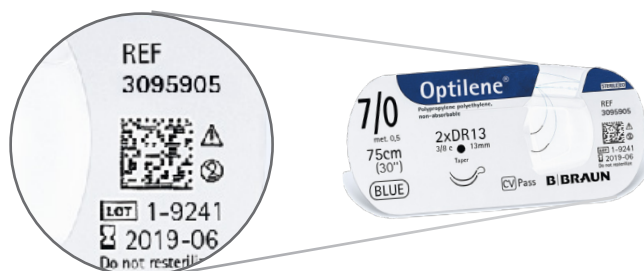

## Code-barres linéaire

Outre le code Datamatrix, B. Braun imprime un code-barres comportant des informations au format EAN-128 sur chaque boîte.



## Code-barres principal

GTIN 13 [numéro d'article international], qui est l'UDI-DI défini dans le Règlement relatif aux Dispositifs médicaux

## Code-barres secondaire

Date de péremption et numéro de lot, qui est l'UDI-PI défini dans le Règlement relatif aux Dispositifs médicaux



## Informations du code EAN-128

- Identifiant d'application de GTIN 13 [numéro d'article international] 01
- Identifiant d'application de date de péremption 17
- Identifiant d'application de numéro de lot 10

# Accessoires B. Braun

## Rack de rangement

Chaque rack de rangement peut contenir jusqu'à 4 boîtes de sutures.

Article	Numéro de code
Rack de rangement	1091255

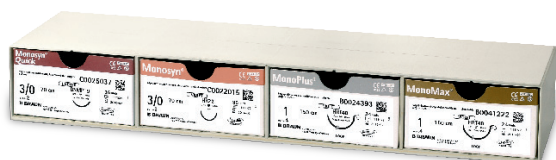

## Support pour racks de rangement

Le support pour racks de rangement peut recevoir jusqu'à 10 racks de rangement.  
Il peut se fixer au mur.

Article	Numéro de code
Support pour racks de rangement	1091247



# B. Braun, la garantie d'un niveau de qualité élevé et constant

Symboles utilisés dans l'étiquetage des dispositifs médicaux d'après la norme ISO 15223 - 1 : 2021

Ne pas réutiliser



Date limite d'utilisation (année + mois)



Stérilisé avec de l'oxyde d'éthylène

STERILE EO

Stérilisé par irradiation

STERILE R

Marquage CE et numéro d'identification de l'organisme notifié. Le produit est conforme aux exigences essentielles de la directive 93/42/CEE relative aux dispositifs médicaux. Ou du Règlement (UE) 2017/745 relatif aux DM.



Code de lot

LOT

ATTENTION (consulter la notice d'utilisation)



REF

# Informations sur les aiguilles

---

Aiguilles chirurgicales B. Braun

---

Caractéristiques des aiguilles B. Braun

---

Génération d'aiguilles CV Pass

---

Types d'aiguilles B. Braun

---

Nomenclature des aiguilles B. Braun

---

Aiguilles B. Braun

---

# Aiguilles chirurgicales B. Braun

Les aiguilles B. Braun ont acquis une reconnaissance au fil des ans pour leur qualité et leurs performances.

## Évolution constante

- B. Braun possède une technologie de pointe et s'engage sans relâche dans le domaine de la recherche et du développement afin d'améliorer les aiguilles en fonction des besoins de toutes les disciplines de la chirurgie.

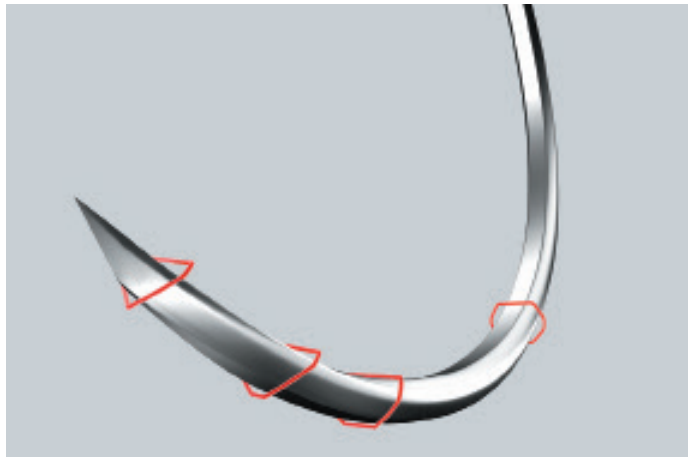

## Plus de 250 types d'aiguilles différents

- B. Braun dispose de plus de 250 types d'aiguilles différents pour répondre aux besoins des actes chirurgicaux et des chirurgiens.

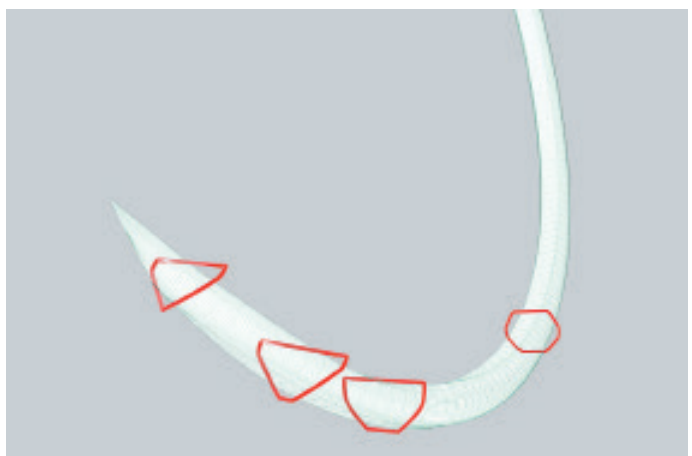
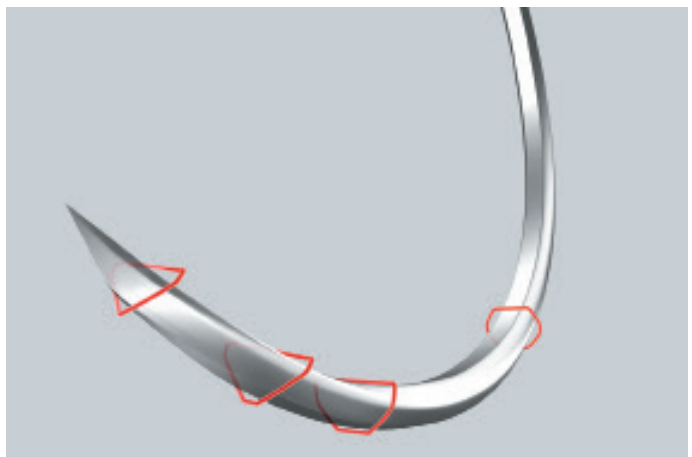

# Caractéristiques des aiguilles B. Braun



Les aiguilles Easyslide et CV Pass sont le résultat de recherches approfondies en technologie métallurgique et d'expérience clinique.

Les aiguilles sont réalisées dans un alliage d'acier inoxydable.

## Résistance à la flexion

- Acier spécial conférant leur résistance aux aiguilles = acier 300
- Résistance à la flexion et à la rupture

## Pénétration

- Conception spécifique de la pointe de l'aiguille
- Force de pénétration constantes, point après point
- Traitement de surface qui améliore la pénétration de l'aiguille



La toute nouvelle génération d'aiguilles triangulaires à pointe de précision B. Braun pour la chirurgie plastique.

## Conception spécifique de la pointe et de la géométrie de l'aiguille

- Pointe fine pour un passage plus facile en douceur
- Bonne durabilité et intégrité de la pointe de l'aiguille
- Aiguille à corps aplati pour une bonne stabilité dans le porte-aiguille



## Ultracilla

### Conception spécifique du corps de l'aiguille

- Micro Cavity Technologie pour un passage moins traumatique dans les tissus



Micro Cavity Technologie

# Génération d'aiguilles CV Pass

Des aiguilles dédiées à la chirurgie cardiovasculaire

## Nouvelle génération d'aiguilles pour la chirurgie cardiovasculaire

- Spécifiquement mise au point pour répondre aux exigences élevées qui s'imposent pendant la chirurgie cardiovasculaire
- Les aiguilles CV Pass sont fabriquées à l'aide d'un alliage d'acier inoxydable de la plus haute qualité (inox de série 300).



## Conception spécifique du corps d'aiguille

Un corps carré aux côtés arrondis confère aux aiguilles CV Pass :

- Une résistance supérieure à la flexion et à la rupture
- Une pénétration optimale même après de multiples passages dans les tissus
- Un passage atraumatique dans les tissus
- Une excellente stabilité dans le porte-aiguille
- Une visibilité améliorée de l'aiguille avec CV Pass Easyblack





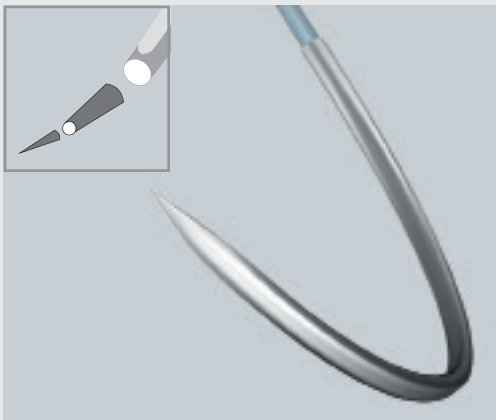
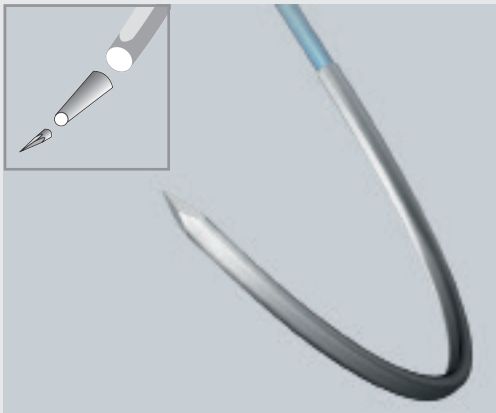

# Types d'aiguilles B. Braun

## Les aiguilles rondes

Aiguille ronde ●	Exemples d'utilisation	Gamme de sutures proposant ces aiguilles
<p>L'aiguille ronde est conçue pour permettre une pénétration aisée des tissus. Le corps de l'aiguille est aplati pour empêcher l'aiguille de tourner dans le porte-aiguille. Cette aiguille est conçue pour les tissus mous. L'aiguille CV Pass avec son corps carré et non aplati permet une résistance accrue à la flexion. Cette aiguille est spécialement conçue pour les indications cardiovasculaires.</p> 	<ul style="list-style-type: none"> <li>■ Tractus gastro-intestinal</li> <li>■ Tractus urinaire</li> <li>■ Organes génitaux (masculins et féminins)</li> <li>■ Système cardiovasculaire (structures cardiaques et vaisseaux sans athérome)</li> <li>■ Système respiratoire</li> <li>■ Chirurgie endocrinienne</li> <li>■ Chirurgie hépatobiliaire</li> <li>■ Membranes (dure-mère, péritoine, péricarde)</li> <li>■ Couche musculaire</li> <li>■ Tissus cellulaires sous-cutanés</li> <li>■ Microchirurgie (vaisseaux, nerfs)</li> <li>■ Muqueuse buccale</li> </ul>	<p><b>Sutures résorbables</b></p> <ul style="list-style-type: none"> <li>■ Novosyn®</li> <li>■ Novosyn® Quick</li> <li>■ Novosyn® CHD</li> <li>■ Monosyn® Quick</li> <li>■ Monosyn®</li> <li>■ MonoPlus®</li> <li>■ MonoMax®</li> </ul> <p><b>Sutures non résorbables</b></p> <ul style="list-style-type: none"> <li>■ Optilene®</li> <li>■ PremiCron®</li> <li>■ Dafilon®</li> <li>■ Supramid®</li> <li>■ Dagrofil®</li> <li>■ Silkam®</li> <li>■ Steelex®</li> </ul> <p><b>Sets</b></p> <ul style="list-style-type: none"> <li>■ Episio-Set</li> <li>■ Steelex®</li> <li>■ Electrode-Set</li> </ul>
<p><b>Aiguille ronde micropointe</b> ◉</p> <p>Cette aiguille ronde avec l'extrémité de la pointe triangulaire améliore la pénétration dans les vaisseaux calcifiés et les tissus scléreux. L'aiguille CV Pass avec son corps carré et non aplati permet une résistance accrue à la flexion. Cette aiguille est spécialement conçue pour les indications cardiovasculaires.</p> 	<ul style="list-style-type: none"> <li>■ Système cardiovasculaire (structures cardiaques et vaisseaux avec athérome)</li> <li>■ Couche musculaire</li> <li>■ Aponévroses</li> <li>■ Ligaments</li> <li>■ Tendons</li> </ul>	<p><b>Sutures résorbables</b></p> <ul style="list-style-type: none"> <li>■ Novosyn®</li> <li>■ Novosyn® Quick</li> <li>■ Novosyn® CHD</li> <li>■ Monosyn®</li> <li>■ MonoPlus®</li> <li>■ MonoMax®</li> </ul> <p><b>Sutures non résorbables</b></p> <ul style="list-style-type: none"> <li>■ Optilene®</li> <li>■ PremiCron®</li> <li>■ Dafilon®</li> <li>■ Supramid®</li> </ul> <p><b>Sets</b></p> <ul style="list-style-type: none"> <li>■ Sternum-Set</li> </ul>

# Types d'aiguilles B. Braun

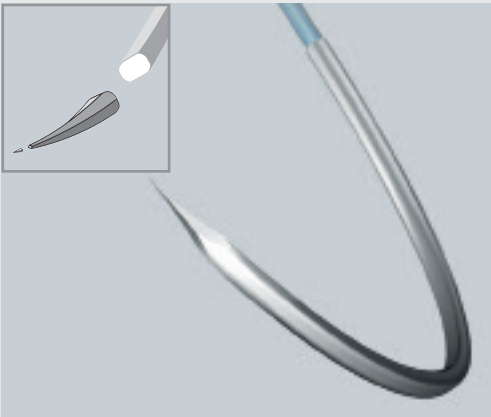
## Les aiguilles rondes

Aiguille ronde pointe diamant 	Exemples d'utilisation	Gamme de sutures proposant ces aiguilles
<p>Aiguille avec pointe tranchante robuste à quatre arêtes qui se prolonge par un corps rond effilé.</p> <p>Cette aiguille assure une bonne pénétration dans les tissus scléreux avec un trauma tissulaire minime.</p> 	<ul style="list-style-type: none"> <li>■ Couche musculaire</li> <li>■ Aponévroses</li> <li>■ Ligaments</li> <li>■ Tendons</li> </ul>	<p><b>Sutures résorbables</b></p> <ul style="list-style-type: none"> <li>■ Novosyn® Quick</li> <li>■ Novosyn®</li> <li>■ Monosyn® Quick</li> <li>■ Monosyn®</li> <li>■ MonoPlus®</li> <li>■ MonoMax®</li> </ul> <p><b>Sutures non résorbables</b></p> <ul style="list-style-type: none"> <li>■ PremiCron®</li> <li>■ Dafilon®</li> <li>■ Supramid®</li> <li>■ Dagrofil®</li> <li>■ Silkam®</li> <li>■ Steelex®</li> </ul> <p><b>Sets</b></p> <ul style="list-style-type: none"> <li>■ Episio-Set</li> <li>■ Steelex®</li> <li>■ Electrode-Set</li> </ul>
<p>Aiguille ronde qui se transforme progressivement en une pointe à trois tranchants. Cette aiguille est spécialement conçue pour la fermeture sternale.</p> 	<ul style="list-style-type: none"> <li>■ Fermeture sternale</li> </ul>	<ul style="list-style-type: none"> <li>■ Steelex®</li> <li>■ Sternum-Set</li> </ul>

**Aiguille ronde pointe mousse** ○

Aiguille ronde et pointe mousse arrondie qui ne transperce pas les tissus ; recommandée pour les tissus parenchymateux pour éviter les dommages tissulaires au niveau des structures environnantes. Aiguille spécialement conçue pour limiter les blessures par piqûre d'aiguille. L'aiguille permet la pénétration du fascia tout en réduisant le risque de blessure accidentelle par piqûre d'aiguille.

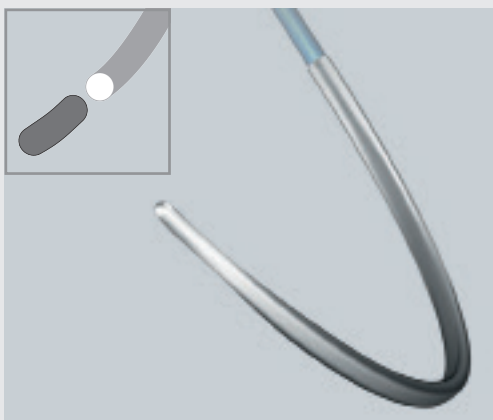

**Exemples d'utilisation**

- Dissection mousse à travers les tissus mous
- Organes parenchymateux
- Sternum (sutures péristernales)

**Gamme de sutures proposant ces aiguilles**

**Sutures résorbables**

- Novosyn® Quick
- Novosyn®
- Monosyn®
- MonoPlus®
- MonoMax®

**Sutures non résorbables**

- Dafilon®
- Silkam®

**Sets**

- Surgical Loop
- Steelex® Sternum-Set

# Types d'aiguilles B. Braun

## Les aiguilles triangulaires

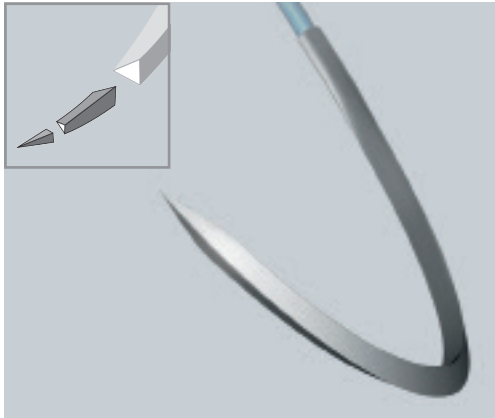
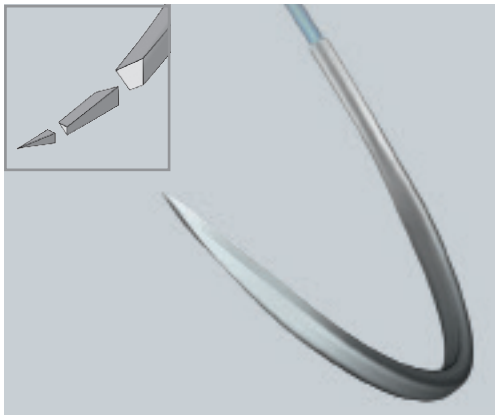
Triangulaire (tranchante sur l'extérieur) ▼	Exemples d'utilisation	Gamme de sutures proposant ces aiguilles
<p>Aiguille de section triangulaire avec un apex à bord tranchant sur l'extérieur de la courbure de l'aiguille. Conçue pour pénétrer dans les tissus.</p> 	<ul style="list-style-type: none"> <li>■ Peau (sutures dermiques et intradermiques)</li> <li>■ Tendons (sutures intra et péri-tendineuses)</li> <li>■ Couche musculaire</li> <li>■ Aponévroses</li> <li>■ Ligaments</li> </ul>	<p><b>Sutures résorbables</b></p> <ul style="list-style-type: none"> <li>■ Novosyn®</li> <li>■ Novosyn® Quick</li> <li>■ Novosyn® CHD</li> <li>■ Monosyn® Quick</li> <li>■ Monosyn®</li> <li>■ MonoPlus®</li> </ul> <p><b>Sutures non résorbables</b></p> <ul style="list-style-type: none"> <li>■ Optilene®</li> <li>■ PremiCron®</li> <li>■ Dafilon®</li> <li>■ Supramid®</li> <li>■ Dagrofil®</li> <li>■ Silkam®</li> <li>■ Steelex®</li> </ul> <p><b>Sets</b></p> <ul style="list-style-type: none"> <li>■ Episio-Set</li> <li>■ Surgical Loop</li> <li>■ Steelex®</li> <li>■ Electrode-Set</li> </ul>
<p>Triangulaire (tranchante sur l'extérieur) avec pointe de précision ▼</p> <p>Aiguille présentant une géométrie spécifique à pointe fine et un apex à bord tranchant sur l'extérieur. Le corps s'aplatit progressivement après la pointe de l'aiguille pour une plus grande stabilité dans le porte-aiguille. Aiguille idéale pour la chirurgie plastique où le résultat esthétique est important.</p> 	<ul style="list-style-type: none"> <li>■ Peau (sutures dermiques et intradermiques)</li> <li>■ Tendons (sutures intra et péri-tendineuses)</li> </ul>	<p><b>Sutures résorbables</b></p> <ul style="list-style-type: none"> <li>■ Novosyn®</li> <li>■ Novosyn® Quick</li> <li>■ Novosyn® CHD</li> <li>■ Monosyn® Quick</li> <li>■ Monosyn®</li> <li>■ MonoPlus®</li> </ul> <p><b>Sutures non résorbables</b></p> <ul style="list-style-type: none"> <li>■ Optilene®</li> <li>■ PremiCron®</li> <li>■ Dafilon®</li> <li>■ Supramid®</li> <li>■ Dagrofil®</li> <li>■ Silkam®</li> </ul> <p><b>Sets</b></p> <ul style="list-style-type: none"> <li>■ Episio-Set</li> </ul>

# Types d'aiguilles B. Braun

## Les aiguilles spatulées

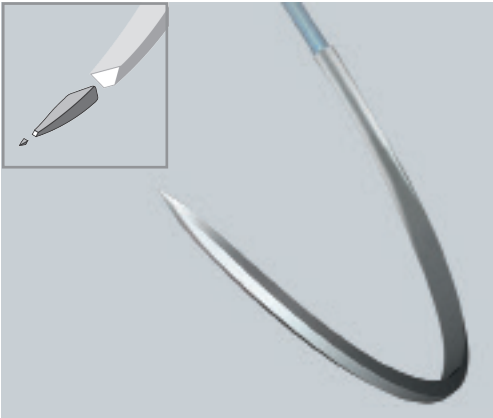
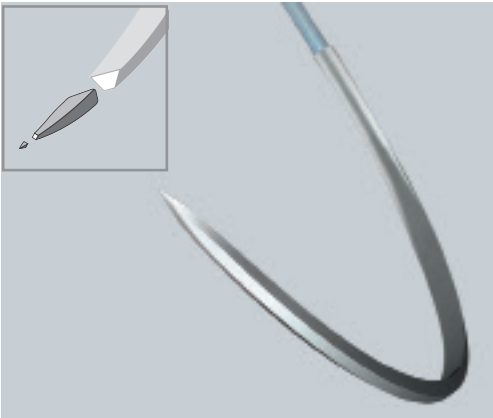
Aiguille spatulée ▼	Exemples d'utilisation	Gamme de sutures proposant ces aiguilles
<p>Pointe d'aiguille spéciale conçue pour traverser les structures ophtalmiques sans endommager la couche supérieure et inférieure du stroma.</p> 	<ul style="list-style-type: none"> <li>■ Ophtalmologie</li> </ul>	<p><b>Sutures résorbables</b></p> <ul style="list-style-type: none"> <li>■ Novosyn®</li> </ul> <p><b>Sutures non résorbables</b></p> <ul style="list-style-type: none"> <li>■ Optilene®</li> <li>■ PremiCron®</li> <li>■ Dafilon®</li> <li>■ Supramid®</li> <li>■ Dagrofil®</li> <li>■ Silkam®</li> </ul>
Aiguille spatulée micro-pointe ▼	Exemples d'utilisation	Gamme de sutures proposant ces aiguilles
<p>Cette micro-aiguille avec pointe microtip est une variation des aiguilles spatulées classiques. La forme trapézoïdale spéciale est conçue pour réduire le risque de pénétration et de coupure accidentelle de plans plus profonds</p> 	<ul style="list-style-type: none"> <li>■ Ophtalmologie</li> <li>■ Nerfs</li> </ul>	<p><b>Sutures résorbables</b></p> <ul style="list-style-type: none"> <li>■ Novosyn®</li> </ul> <p><b>Sutures non résorbables</b></p> <ul style="list-style-type: none"> <li>■ Dafilon®</li> <li>■ Silkam®</li> </ul>

# Nomenclature des aiguilles B. Braun

Pour distinguer les différents types d'aiguilles, B. Braun utilise la nomenclature suivante :

A	B	C	12	D
Courbure de l'aiguille	Corps de l'aiguille	Pointe de l'aiguille	Longueur de l'aiguille	Précisions complémentaires
<b>S</b> 1/8 cercle	<b>R</b> rond	<b>T</b> diamant	Correspond à la distance entre la pointe de l'aiguille et la zone de sertissage, distance mesurée le long de l'aiguille en mm.	<b>f</b> aiguille flat (øaig = øfil)
<b>V</b> 1/4 cercle	<b>S</b> triangulaire	<b>N</b> mousse		<b>s</b> aiguille renforcée
<b>D</b> 3/8 cercle	<b>L</b> spatulé	<b>S</b> sternale		<b>ss</b> aiguille très renforcée
<b>H</b> 1/2 cercle	<b>G</b> trapézoïdal (Golf)	<b>C</b> micropointe		<b>v</b> aiguille sécable (break-off)
<b>F</b> 5/8 cercle		<b>MP</b> pointe de précision		<b>b</b> aiguille noire
<b>G</b> droite		<b>m</b> aiguille de microchirurgie		
<b>P</b> composite / progressive		<b>mV</b> microvasculaire		
<b>J</b> crochet				
<b>SK</b> ski				
Exemple :				
<b>H</b>	<b>R</b>	<b>C</b>	<b>26</b>	

HRC 26 : Aiguille 1/2 cercle à corps rond avec pointe triangulaire micropointe, longueur 26 mm.

## Angle de courbure de l'aiguille "Take off" – aiguille amovible

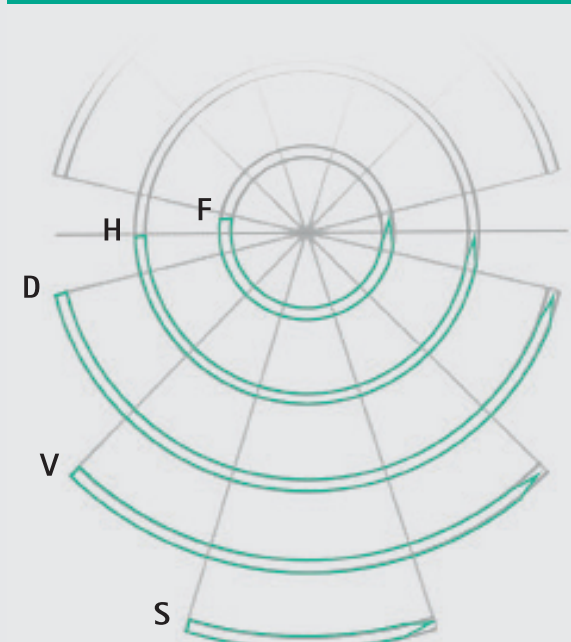

- S 1/8 cercle
- V 1/4 cercle
- D 3/8 cercle
- H 1/2 cercle
- F 5/8 cercle

Pour détacher l'aiguille du fil sans l'aide de ciseaux, tendre la suture en tirant dessus et saisir solidement l'aiguille dans le porte-aiguille. Un coup sec sur le porte-aiguille va alors détacher l'aiguille de la suture.

## Autres courbures

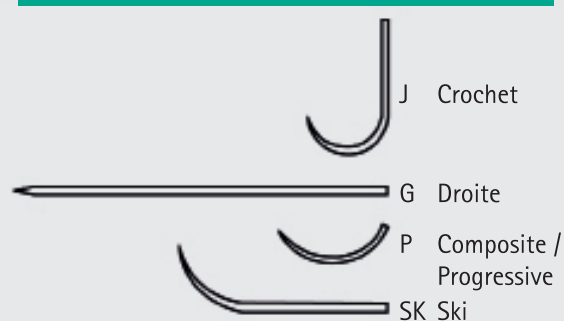

# Aiguilles B. Braun





## Aiguille ronde (aiguille microvasculaire) ●

### Aiguille ronde microvasculaire

#### 3/8 cercle

	angle	longueur mm	diamètre microns			angle	longueur mm	diamètre microns	
<b>DRmV 6b</b> 	135°	6,4	140 μ		<b>DRmV 10b</b> 	135°	9,3	200 μ	
<b>DRmV 8b</b> 	135°	7,9	140 μ		<b>DRmV 13b</b> 				



#### Composite / progressive

	angle	longueur mm	diamètre microns			angle	longueur mm	diamètre microns	
<b>PRmV 8b</b> 	85° / 101°	7,9	200 μ		<b>PRmV 10b</b> 	95° / 90°	9,3	200 μ	









## Aiguille ronde (aiguille de microchirurgie) ●

### Aiguille ronde de microchirurgie

#### 1/2 cercle

	angle	longueur mm	diamètre microns			angle	longueur mm	diamètre microns	
<b>HRm 4</b>	180°	4,0	70 μ		<b>HRm 8</b>	180°	7,8	140 μ	
<b>HRm 6</b>	180°	6,5	200 μ						

#### 3/8 cercle

	angle	longueur mm	diamètre microns			angle	longueur mm	diamètre microns	
<b>DRm 3</b>	135°	3,8	50 μ		<b>DRm 6</b>	135°	6,4	140 μ	
<b>DRm 4</b>	135°	4,0	70 μ		<b>DRm 8</b>	135°	7,9	140 μ	
<b>DRm 4s</b>	135°	4,0	140 μ		<b>DRm 10b</b> 	135°	9,3	200 μ	
<b>DRm 5</b>	135°	5,0	100 μ						















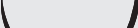

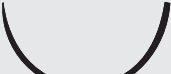

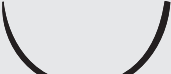

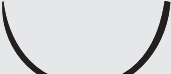

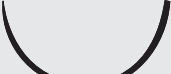

#### Composite / progressive

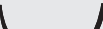
	angle	longueur mm	diamètre microns			angle	longueur mm	diamètre microns	
<b>PRm 4</b>	95° / 100°	4,0	70 μ		<b>PRm 6</b>	100° / 95°	6,4	140 μ	
<b>PRm 5</b>	100° / 90°	5,0	100 μ						

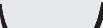
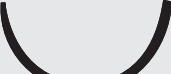
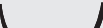
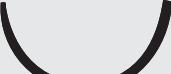
# Aiguilles B. Braun

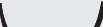
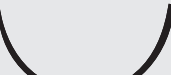
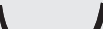
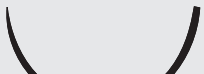
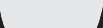
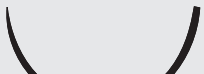
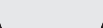
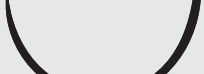
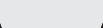
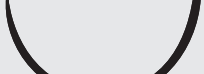
## Aiguille ronde ●

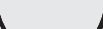
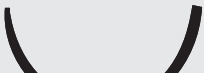
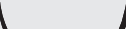
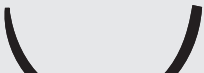
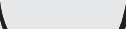
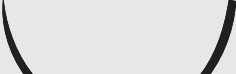
1/2 cercle

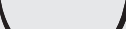
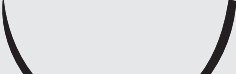
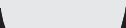
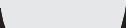
HR 6		HR 22ss	
HR 8		HR 22ss "Take off"	
HR 10f		HR 23	
HR 10		HR 26f	
HR 13f		HR 26	
HR 13		HR 26 "Take off"	
HR 13b 		HR 26b 	
HR 13ss		HR 26s	
HR 17f		HR 26s "Take off"	
HR 17		HR 26ss	
HR 17 "Take off"		HR 26ss "Take off"	
HR 17b 		HR 27	
HR 17s		HR 30	
HR 18		HR 30 "Take off"	
HR 20		HR 30s	
HR 20 "Take off"		HR 30s "Take off"	
HR 20b 		HR 30ss	
HR 22		HR 30ss "Take off"	
HR 22 "Take off"		HR 37	
HR 22b 		HR 37 "Take off"	
HR 22s			
HR 22s "Take off"			



**Aiguille ronde ●**

1/2 cercle

**HR 37s**  
**HR 37s "Take off"**



**HR 48**  
**HR 48 "Take off"**



**HR 37ss**  
**HR 37ss "Take off"**



**HR 60**



**HR 40**



**HR 65**  
**HR 65 "Take off"**



**HR 40s**  
**HR 40s "Take off"**



**HR 40ss**



**HR 70**



**HR 43**  
**HR 43 "Take off"**



**HR 43s**





**HR 76**











# Aiguilles B. Braun

## Aiguille ronde ●



### 3/8 cercle

DR 6	
DR 6s	
DR 8f	
DR 8	
DR 10f	
DR 10	
DR 10s	
DR 12	
DR 13	
DR 13s	
DR 15	
DR 18	

DR 18b 	
DR 22	
DR 22b 	
DR 26	
DR 32	
DR 39	
DR 48 DR 48 "Take off"	

### 5/8 cercle

FR 10	
FR 13	
FR 17	
FR 22	
FR 26	
FR 26s	

FR 36	
FR 40	
FR 110	

**Aiguille ronde ●**

**Crochet**

JR 30



JR 36ss



JR 30s



JR 40s



JR 30ss



**Ski**

SKR 19



SKR 26  
SKR 26 "Take off"



**Composite / progressive**

PR 24



**Droite**

GR 19



GR 65

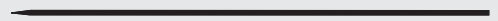

GR 35

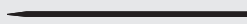

GR 70

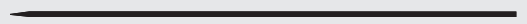

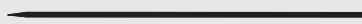

GR 51





# Aiguilles B. Braun

## Aiguille ronde micropointe (microvasculaire)

### 3/8 cercle



	angle	longueur mm	diamètre microns	
<b>DRCmV 10b</b> 	135°	9,3	200 µ	

### Composite / progressive





	angle	longueur mm	diamètre microns	
<b>PRCmV 10b</b> 	95° / 90°	9,3	200 µ	

## Aiguille ronde micropointe (microchirurgie)

### 3/8 cercle

	angle	longueur mm	diamètre microns			angle	longueur mm	diamètre microns	
<b>DRCm 3</b>	135°	3,5	100 µ		<b>DRCm 6</b>	135°	6,4	140 µ	
<b>DRCm 4</b>	135°	4,2	140 µ		<b>DRCm 8</b>	135°	7,9	140 µ	
<b>DRCm 5</b>	135°	5,0	100 µ		<b>DRCm 10b</b> 	135°	9,3	200 µ	

### Composite / progressive

	angle	longueur mm	diamètre microns			angle	longueur mm	diamètre microns	
<b>PRCm 4</b>	95° / 110°	4,0	70 µ		<b>PRCm 6</b>	100° / 95°	6,4	140 µ	
<b>PRCm 5</b>	100° / 95°	5,1	100 µ		<b>PRCm 10b</b> 	95° / 90°	9,3	200 µ	

**Aiguille ronde micropointe** 

1/2 cercle

HRC 10



HRC 13



HRC 17



HRC 17 "Take off"

HRC 17b 



HRC 17f



HRC 18



HRC 18b 



HRC 20



HRC 20s



HRC 22



HRC 22b 



HRC 26



HRC 26 "Take off"

HRC 26b 



HRC 26s



HRC 27



HRC 27b 



HRC 30



HRC 30s



HRC 37



HRC 37 "Take off"

HRC 37s



HRC 37ss



HRC 40



HRC 40s



HRC 43



HRC 43 "Take off"

# Aiguilles B. Braun

## Aiguille ronde micropointe

### 1/2 cercle

HRC 43s  
HRC 43s "Take off"



HRC 55



HRC 48



HRC 80



### 3/8 cercle

DRC 6



DRC 13s



DRC 8



DRC 15



DRC 10



DRC 18



DRC 10b



DRC 18b



DRC 10s



DRC 22



DRC 12



DRC 26



DRC 13



**Aiguille ronde micropointe** 

5/8 cercle

FRC 10



Crochet

JRC 30s



Composite / progressive

PRC 10



PRC 24

PRC 13



PRC 13b



Droite

GRC 24

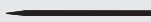

# Aiguilles B. Braun

## Aiguille ronde diamant

1/2 cercle

HRT 13



HRT 17f



HRT 17



HRT 20s



HRT 22



HRT 26



HRT 26s



HRT 30



HRT 30s



HRT 37

HRT 37 "Take off"



HRT 37s



HRT 40



HRT 40s



HRT 43

HRT 43 "Take off"



HRT 43s



HRT 48



HRT 55



HRT 80





**Aiguille ronde diamant ⊕**

3/8 cercle

DRT 12



DRT 22



DRT 18



DRT 26



DRT 32



5/8 cercle

FRT 17



FRT 65



Droite

GRT 40

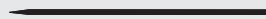

# Aiguilles B. Braun

## Aiguille ronde diamant micropointe ⊕

3/8 cercle

DRTM 8



DRTM 12



## Aiguille ronde sternale ▲

1/2 cercle

HRS 40



HRS 55



HRS 48



HRS 60



Aiguille ronde mousse ●

1/2 cercle

HRN 30



HRN 50s



HRN 35



HRN 35 "Take off"

HRN 60



HRN 40



HRN 65



HRN 45



HRN 75



HRN 48



HRN 85



HRN 50



HRN 50 "Take off"

3/8 cercle

DRN 16



DRN 64



DRN 25



Droite

GRN 12



# Aiguilles B. Braun

## Aiguille ronde mousse ●

1/2 cercle

**HRB 26**

HRB 26 "Take off"



**HRB 48**

HRB 48 "Take off"



**HRB 37s**

HRB 37s "Take off"



**HRB 65**

















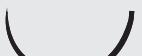



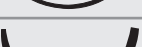
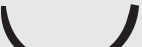





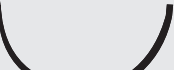

**HRB 40s**

HRB 40s "Take off"

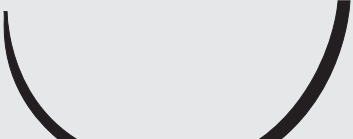

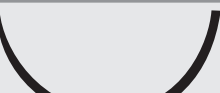
## Aiguille triangulaire (tranchante sur l'extérieur) ▼

1/2 cercle

HS 9			
HS 15		HS 40	
HS 17s "Take off"			
HS 17ss "Take off"		HS40s HS40s "Take off"	
HS 18			
HS 21		HS 40ss HS 40ss "Take off"	
HS 21 "Take off"			
HS 23			
HS 23 "Take off"			
HS 23ss		HS 48f	
HS 23ss "Take off"			
HS 26			
HS 26s		HS 48 HS 48 "Take off"	
HS 26s "Take off"			
HS 26ss		HS 55	
HS 26ss "Take off"			
HS 30			
HS 30 "Take off"		HS 60	
HS 37			
HS 37s		HS 120	
HS 37ss			
HS 37ss "Take off"			

# Aiguilles B. Braun

## Aiguille triangulaire (tranchante sur l'extérieur) ▼

### 3/8 cercle

DS 9



DS 12



DS 16f



DS 16



DS 19f



DS 19



DS 24

DS 24 "Take off"



DS 30

DS 30 "Take off"



DS 35



DS 39



DS 45



DS 48



DS 60



DS 76



DS 90



DS 100



### 5/8 cercle

FS 25



## Aiguille triangulaire (tranchante sur l'extérieur) ▼

Droite

GS 13



GS 20



GS 25



GS 40



GS 45



GS 51



GS 51v



break-off

GS 60



GS 65



GS 65v



break-off

GS 75

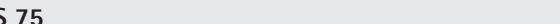

GS 81

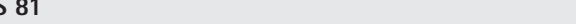

GS 90v









break-off















# Aiguilles B. Braun

## Aiguille triangulaire (tranchante sur l'extérieur) avec pointe de précision ▼

### 1/2 cercle

HSMP 7		HSMP 18	
HSMP 9		HSMP 23	
HSMP 12			
HSMP 15			

### 3/8 cercle

DSMP 6		DSMP 19	
DSMP 7		DSMP 24	
DSMP 9		DSMP 24s	
DSMP 11		DSMP 30	
DSMP 13		DSMP 35	
DSMP 15		DSMP 39	
DSMP 16			
DSMP 16s			



### Composite / progressive

PSMP 16			
---------	---	--	--



## Aiguille spatulée de microchirurgie ▼

### 1/2 cercle

	angle	longueur mm	diamètre microns			angle	longueur mm	diamètre microns	
<b>HLm 6</b>	160°	5,6	150 μ		<b>HLm 8</b>	175°	8,0	200 μ	
<b>HLm 6s</b>	175°	6,0	200 μ						

### 3/8 cercle

	angle	longueur mm	diamètre microns			angle	longueur mm	diamètre microns	
<b>DLm 4</b>	135°	4,0	125 μ		<b>DLm 6</b>	140°	6,1	150 μ	
<b>DLm 5</b>	140°	4,9	150 μ		<b>DLm 6s</b>	137°	6,6	200 μ	

### 1/4 cercle

	angle	longueur mm	diamètre microns	
<b>VLm 6s</b>	97°	6,6	200 μ	

### 1/8 cercle

	angle	longueur mm	diamètre microns	
<b>SLm 6</b>	44°	6,2	150 μ	

### Composite / progressive

	angle	longueur mm	diamètre microns	
<b>PLm 5</b>	90° / 55°	4,8	150 μ	

### Droite

	angle	longueur mm	diamètre microns	
<b>GLm 16</b>	-	16,0	150 μ	

# Aiguilles B. Braun

## Aiguille spatulée micropointe ▾

1/2 cercle

HLM 6



HLM 8



1/4 cercle

VLM 6



VLM 10



VLM 8



## Aiguille trapézoïdale micro-gravée (Golf) à pointe de précision ▾

3/8 cercle

DGMP 11



DGMP 13



DGMP 16



DGMP 19



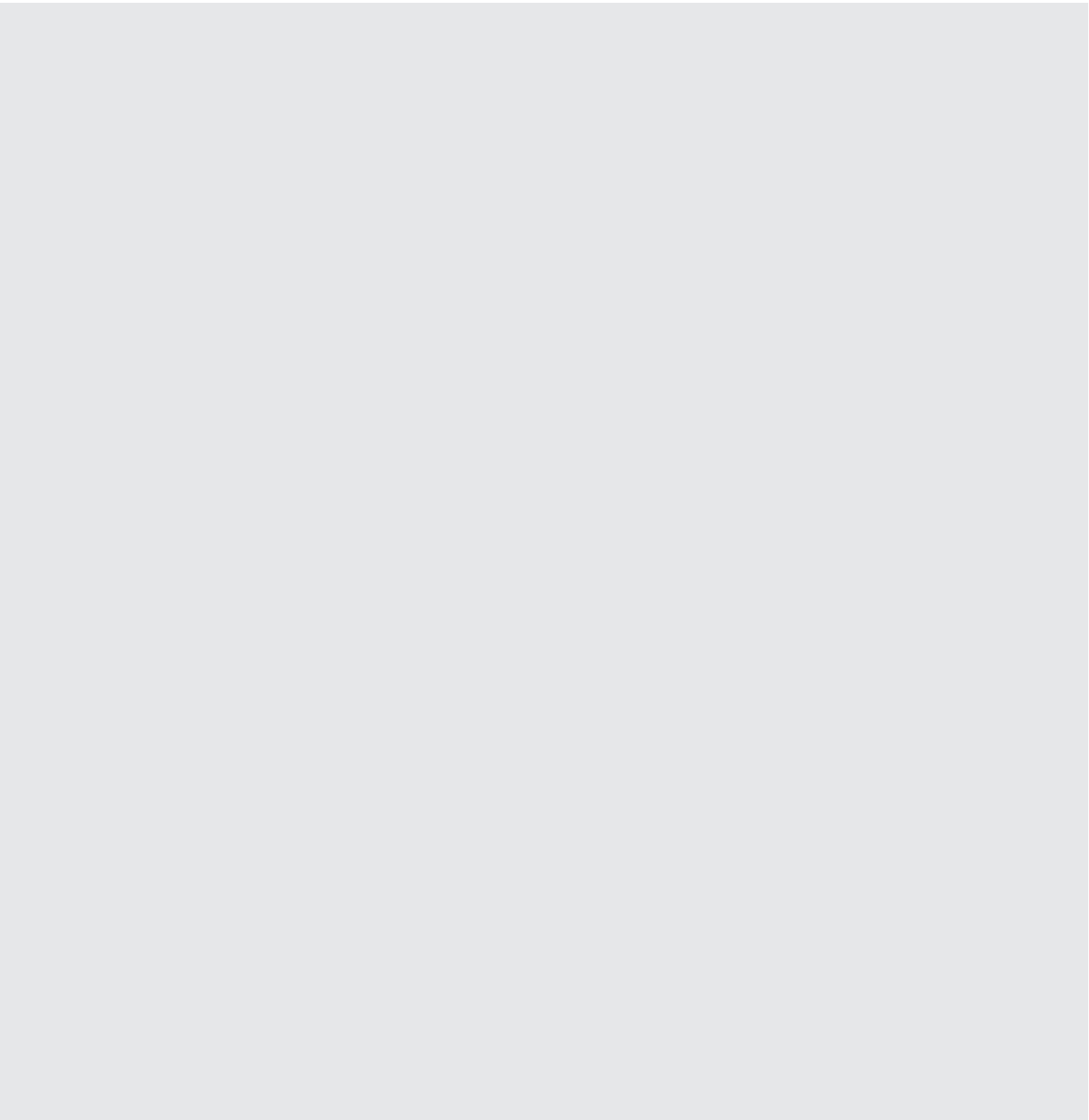

# Sutures résorbables

Novosyn® Quick

---

Novosyn®

---

Novosyn® CHD

---

Monosyn® Quick

---

Monosyn®

---

MonoPlus®

---

MonoMax®

---

# Novosyn® Quick

## Tresse synthétique résorbable à court terme

### Description

Novosyn® Quick est une tresse synthétique à résorption rapide, à base d'acide polyglycolique et d'acide L-Lactique dans la proportion 90/10, enduite, disponible en incolore.

Novosyn® Quick est indiqué pour le rapprochement des tissus mous, lorsqu'un support de la plaie à court terme est requis et que la résorption rapide de la suture apporte un effet bénéfique.

### Propriétés

- Conserve 50% de sa résistance initiale après 5 jours
- Résorption totale en environ 42 jours

### Indications

- Chirurgie gynécologique / obstétrique
- Chirurgie pédiatrique
- Fermeture cutanée et de muqueuse buccale

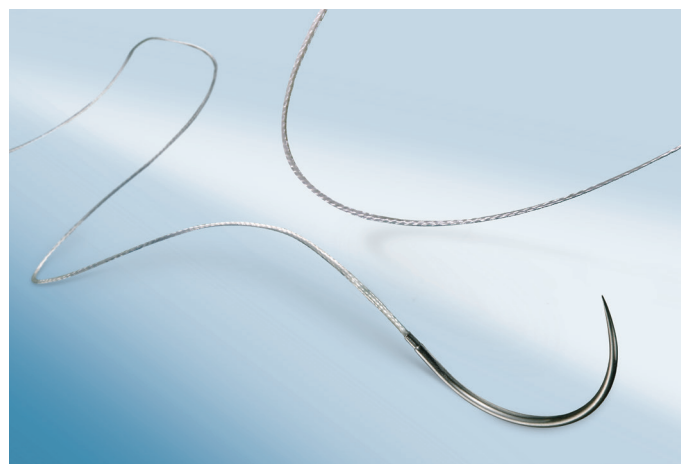

Caractéristiques produit	
Structure	Tresse 
Couleur	Incolore
Composition chimique	glycolide (90 %) et L-lactide (10 %)
Enduction	glycolide (30 %), L-lactide (70%) et stéarate de calcium
Origine	Synthétique
Calibres	USP 6/0 (Déc. 0,7) à USP 2 (Déc. 5)
Résistance à la traction	50% après 5 jours d'implantation 0% après 14 jours d'implantation
Résorption	Par hydrolyse, totale en 42 jours
Stérilisation	Irradiation Gamme

# Novosyn® Quick

Combinaison fil-aiguille







Aiguille longueur mm	Fil longueur cm couleur	USP métrique							
		6/0 (0.7)	5/0 (1)	4/0 (1.5)	3/0 (2)	2/0 (3)	0 (3.5)	1 (4)	2 (5)
Aiguille ronde 1/2 cercle									
HR 13	70 incolore	*C3046001	*C3046002						
HR 17	70 incolore	C3046011	C3046012	C3046013	C3046014				
HR 22	70 incolore			C3046029	C3046030	C3046031			
HR 26	70 incolore					C3046042	*C3046043		
HR 37	70 incolore					C3046005	*C3046006		
HR 37s	90 140					C3046595 C3046591	C3046596	C3046597	
HR 40s	90 incolore						C3046556	C3046557	*C3046558
Aiguille ronde 5/8 cercle									
FR 36	90 incolore						*C3046078	C3046079	
FR 40	90 incolore						*C3046019		

\* Fabrication spéciale. Délai d'approvisionnement minimum : 8 à 12 semaines.

# Novosyn® Quick

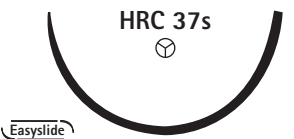
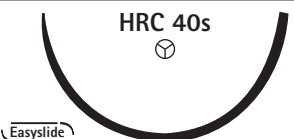
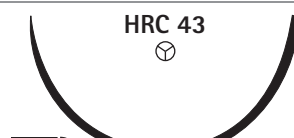
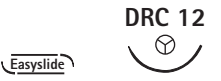
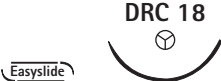
Combinaison fil-aiguille

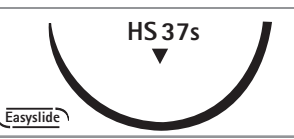

Aiguille longueur mm	Fil longueur cm couleur	USP métrique							
		6/0 (0.7)	5/0 (1)	4/0 (1.5)	3/0 (2)	2/0 (3)	0 (3.5)	1 (4)	2 (5)
Aiguille ronde micropointe 1/2 cercle									
 HRC 37s	90 incolore				*C3046360	C3046651	C3046652	*C3046653	
 HRC 40s	90 incolore						*C3046003		
 HRC 43	90 incolore						C3046662	C3046365	
Aiguille ronde micropointe 3/8 cercle									
 DRC 12	70 incolore		*C3046311						
 DRC 18	70 incolore			*C3046320	*C3046321				
Aiguille triangulaire (tranchante sur l'extérieur) 1/2 cercle									
 HS 18	45 70 incolore			*C3046226	*C3046227				
 HS 37s	90 incolore					C3046240	C3046241	*C3046242	
 HS 40s	90 incolore						*C3046586	*C3046587	
 HS 48	90						*C3046525		

\* Fabrication spéciale. Délai d'approvisionnement minimum : 8 à 12 semaines.

# Novosyn® Quick

Combinaison fil-aiguille



Aiguille longueur mm	Fil longueur cm couleur	USP métrique							
		6/0 (0.7)	5/0 (1)	4/0 (1.5)	3/0 (2)	2/0 (3)	0 (3.5)	1 (4)	2 (5)
Aiguille triangulaire (tranchante sur l'extérieur) 3/8 cercle									
DS 12	70 incolore	*C3046201	C3046202	C3046203					
DS 16	70 incolore		*C3046212	C3046213	C3046214				
DS 19	45 70 90 incolore		C3046219	C3046220 C3046420	C3046221 C3046421 *C3046224	*C3046422			
DS 24	70 incolore			C3046234	C3046235	C3046236			
DS 30	90				*C3046246	C3046247	C3046248		

Aiguille triangulaire droite									
GS 45	70 incolore				*C3046515				
GS 51	70 incolore			*C3046271	C3046272	*C3046273	*C3046274		

\* Fabrication spéciale. Délai d'approvisionnement minimum : 8 à 12 semaines.



# Novosyn<sup>®</sup> Quick

Combinaison fil-aiguille



Aiguille longueur mm	Fil longueur cm couleur	USP métrique							
		6/0 (0.7)	5/0 (1)	4/0 (1.5)	3/0 (2)	2/0 (3)	0 (3.5)	1 (4)	2 (5)
Aiguille triangulaire avec pointe de précision(tranchante sur l'extérieur) 3/8 cercle									
 DSMP 11	45 70 incolore	C3046607 *C3046603							
 DSMP 13	45 incolore		C3046619	C3046620					
 DSMP 16	45 70 incolore		*C3046611	C3046685	C3046686				
 DSMP 19	45 70 incolore			C3046629 C3046529	*C3046630 C3046530	*C3046631 *C3046531			
 DSMP 24	70 incolore				C3046657	C3046658			

\* Fabrication spéciale. Délai d'approvisionnement minimum : 8 à 12 semaines.

C Boîte de 36	B Boîte de 24	G Boîte de 12	M Boîte de 6
---------------	---------------	---------------	--------------



# Novosyn®

## Tresse synthétique résorbable à moyen terme

### Description

Novosyn® est une tresse résorbable synthétique à base d'acide polyglycolique et d'acide L-Lactique dans la proportion 90/10, enduite, disponible en violet et en incolore.

Novosyn® est indiqué pour le rapprochement des tissus mous et pour la ligature dans toutes les spécialités chirurgicales où la pratique requiert l'utilisation de tresses résorbables à moyen terme.

### Propriétés

- Conserve 40-50% de sa résistance initiale après 21 jours
- Résorption complète en 56 à 70 jours

### Indications



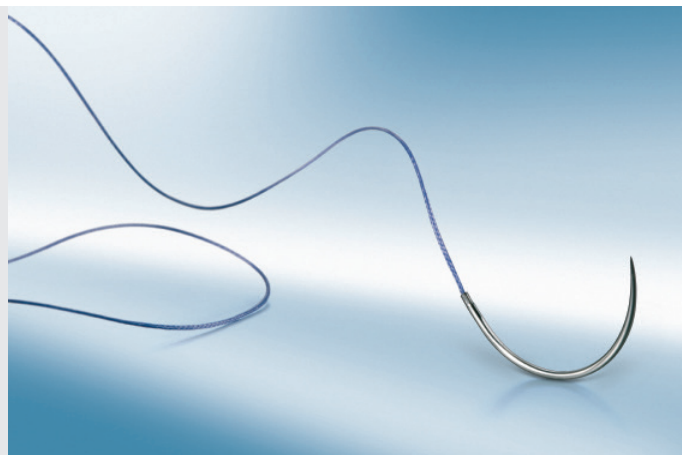



- Chirurgie générale et digestive
- Gynécologie / obstétrique
- Chirurgie ophtalmique
- Chirurgie Urologique
- Fermetures cutanées et sous-cutanées
- Microchirurgie











Novosyn®

### Aperçu produit :



Structure	Tresse
Couleur	Violet ou Incolore
Composition chimique	Acide polyglycolique / acide L-lactique (90/10)
Enduction	Acide polyglycolique / acide L-lactique / Stéarate de calcium
Origine	Synthétique
Calibres	USP 8/0 - 2 (Déc. 0,4 - 5)
Résorption	Résorption par hydrolyse
Stérilisation	Oxyde d'Éthylène

Aiguille		Fil		USP métrique								
angle	longueur mm	diamètre microns	longueur cm	couleur	8/0	7/0	6/0	5/0	4/0	3/0	2/0	0
					0,4	0,5	0,7	1	1,5	2	3	3,5
Aiguille ronde de microchirurgie 3/8 cercle												
135°	<b>DRm 6</b> 	140 μ	20	*G0068145								
			35	*G0068146								
			Violet									
Aiguille spatulée de microchirurgie 3/8 cercle												
140°	<b>2xDLm 5</b> 	150 μ	30	*G0068699								
			Violet									
140°	<b>DLm 6</b> 	150 μ	15	*G0068615								
			30	*G0068724								
			Violet									
140°	<b>2xDLm 6</b> 	150 μ	30	G0068702								
			45	G0068701								
			Violet									
137°	<b>DLm 6s</b> 	200 μ	30	G0068620	G0068621							
			Violet									
137°	<b>2xDLm 6s</b> 	200 μ	30	G0068710	G0068712							
			45	G0068713	G0068711							
			Violet									









\* Fabrication spéciale. Délai d'approvisionnement minimum : 8 à 12 semaines.

Aiguille			Fil	USP métrique								
angle	longueur mm	diamètre microns		longueur cm	8/0 0,4	7/0 0,5	6/0 0,7	5/0 1	4/0 1,5	3/0 2	2/0 3	0 3,5
Aiguille spatulée micropointe 1/2 cercle												
160°	<b>2xHLM 6</b> 	150 μ	30 Violet	G0068715								
175°	<b>2xHLM 8</b> 	200 μ	30 Violet	*G0068740		*G0068741						
			45 Incolore		*G0069740							
180°	<b>2xHLM 8</b> 	330 μ	45 Violet			G0068966	*G0068967					
180°	<b>2xHLM 8</b> 	430 μ	45 Violet					*G0068968				
Aiguille spatulée micropointe 1/4 cercle												
90°	<b>2xVLM 6</b> 	240 μ	30 Violet				*G0068616					
			45 Violet	*C0068732	*G0068737							
90°	<b>VLM 8</b> 	330 μ	45 Violet				*G0068778					
			70 Violet			*G0068299						
90°	<b>2xVLM 8</b> 	330 μ	20 Violet				*G0068733					
			45 Incolore			G0068734	G0068735	*G0068736				
90°	<b>VLM 10</b> 	330 μ	45 Violet				G0068718					
			45 Violet			*G0068738	*G0068739					







\* Fabrication spéciale. Délai d'approvisionnement minimum : 8 à 12 semaines.

Aiguille longueur mm	Fil longueur cm couleur	USP métrique							
		8/0 0,4	7/0 0,5	6/0 0,7	5/0 1	4/0 1,5	3/0 2	2/0 3	0 3,5
Aiguille ronde 1/2 cercle									
HR 10 	70 Violet			*C0068002	*C0068003				
	70 Violet			C0068006	C0068007	C0068008	*C0068009		
HR 13 	70 Incolore				*C0069007	*C0069008			
	70 Violet							*C0068110	*C0068111
HR 17 	70 Violet			*C0068011	C0068012	C0068013	C0068014	C0068015	*C0068016
	90 Violet					*C0068853	*C0068854	*C0068855	
	70 Incolore				*C0069012	C0069013	C0069014	*C0069015	

\* Fabrication spéciale. Délai d'approvisionnement minimum : 8 à 12 semaines.







Aiguille longueur mm	Fil longueur cm couleur	USP métrique							
		6/0 0,7	5/0 1	4/0 1,5	3/0 2	2/0 3	0 3,5	1 4	2 5
Aiguille ronde 1/2 cercle									
 HR 17s	70			*C0068113	*C0068114	*C0068115	*C0068116	*C0068118	
	Violet								
 HR 20	70			C0068765N1	C0068766N1				
	Violet								
 HR 22	70		*C0068028	C0068029N1	C0068030N1	C0068031N1	*C0068032		*C0068443
	90			*C0068438	C0068877N1	*C0068881			
	Violet								
 HR 22	70				C0069030	*C0069031			
	Incolore								
 2xHR 22	90				*C0068874	*C0068875			
	Violet								
 HR 22s	70					C0068036N1	C0068037N1	C0068038N1	
	Violet								
 HR 22ss	70							C0068033	
	Violet								
 HR 26	70		*C0068039	C0068040N1	C0068041N1	C0068042N1	C0068043N1	C0068044N1	*C0068034
	90			*C0068540	C0068541N1	C0068542N1	C0068543N1	C0068544	*C0068545
	Violet								
 HR 26	70			*C0069040	C0069041N1	C0069042N1	*C0069043		
	Incolore								

\* Fabrication spéciale. Délai d'approvisionnement minimum : 8 à 12 semaines.







Aiguille longueur mm	Fil longueur cm couleur	USP métrique								
		5/0 1	4/0 1,5	3/0 2	2/0 3	0 3,5	1 4	2 5	3 6	
Aiguille ronde 1/2 cercle										
	90 Violet			*C0068901	C0068902					
	70			C0068089N1	C0068090N1	C0068091N1	C0068092N1	C0068093		
	90 Violet						C0068592N1			
	70 Incolore				C0069090	*C0069091	*C0069092			
	90 Violet						C0068580	C0068642		
	70		C0068035	C0068046N1	C0068047N1	C0068048N1	C0068049N1	*C0068045		
	90 Violet			C0068446	C0068447N1	C0068448N1	*C0068645			
	70			C0068050N1	C0068051N1	C0068052N1	C0068053N1	C0068054		
	90 Violet			C0068550N1	C0068551N1	C0068552N1	C0068553N1			
	70			C0068094N1	C0068095N1	C0068096N1	C0068097N1	C0068098		
	90 Violet					C0068956N1				
	70 90 Incolore				*C0069095	*C0069096	*C0069097	*C0069597		

\* Fabrication spéciale. Délai d'approvisionnement minimum : 8 à 12 semaines.











Aiguille  longueur mm	Fil  longueur cm couleur	USP métrique							
		5/0 1	4/0 1,5	3/0 2	2/0 3	0 3,5	1 4	2 5	3 6
Aiguille ronde 1/2 cercle									
 HR 37ss	70				C0068121	*C0068122	C0068123		
	90					C0068576	C0068577N1	B0068655	
	Violet								
 HR 40	90					C0068569N1	C0068571N1	B0068661	
	Violet								
 HR 40s	70			*C0068059	C0068055N1	C0068056N1	C0068057N1	C0068058	
	90			*C0068466	C0068467N1	C0068556N1	C0068557N1	B0068558	
	Violet								
 HR 48	90				C0068560N1	C0068561N1	C0068562N1	B0068563	
	Violet								
	90					*C0069561	*C0069562		
	Incolore								
 HR 65	90						B0068639	B0068640	
	Violet								
 HR 65 Boucle	240						*B0068929	*B0068930	
	Violet								
 HR 70	70						*B0068183		
	Violet								







\* Fabrication spéciale. Délai d'approvisionnement minimum : 8 à 12 semaines.

Aiguille longueur mm	Fil longueur cm couleur	USP métrique								
		6/0 0,7	5/0 1	4/0 1,5	3/0 2	2/0 3	0 3,5	1 4	2 5	
Aiguille ronde 3/8 cercle										
<b>DR 12</b> 	45		*C0068134							
	70 Violet	*C0068434	*C0068435	*C0068436						
<b>2xDR 12</b> 	45 Incolore	*C0069725								
<b>DR 18</b> 	70 Violet		*C0068155	C0068150	C0068151					
<b>DR 22</b> 	70 Violet			*C0068159	C0068160N1	C0068161				
<b>DR 26</b> 	70 Violet				C0068164	C0068165N1				
<b>DR 32</b> 	70 Violet				C0068170	C0068171N1	C0068172	C0068173	C0068168	





\* Fabrication spéciale. Délai d'approvisionnement minimum : 8 à 12 semaines.

Aiguille longueur mm	Fil longueur cm couleur	USP métrique							
		6/0 0,7	5/0 1	4/0 1,5	3/0 2	2/0 3	0 3,5	1 4	2 5
Aiguille ronde 5/8 cercle									
 FR 26	70				C0068414	C0068415	C0068416	C0068417	
	90					*C0068775	*C0068810		
	Violet								
 FR 26s	70							C0068428	
	Violet								
 FR 36	70					C0068425	C0068426		
	Violet								
 FR 40	70						C0068490	*C0068491	
	90						*C0068866		
	Violet								
Aiguille ronde ski									
 SKR 19	20			*C0068752					
	Violet								
 SKR 26	20				C0068746	*C0068749			
	120				*C0068744	*C0068751			
	Violet								
Aiguille triangulaire droite									
 GR 19	70				*C0068285				
	Violet								
 GR 51	90					*C0068185			
	Violet								
 GR 65	90					*C0068994			
	Violet								





\* Fabrication spéciale. Délai d'approvisionnement minimum : 8 à 12 semaines.



Aiguille longueur mm	Fil longueur cm couleur	USP métrique							
		6/0 0,7	5/0 1	4/0 1,5	3/0 2	2/0 3	0 3,5	1 4	2 5
Aiguille ronde micropointe 1/2 cercle									
 <b>HRC 17</b>	70			C0068313	C0068314	*C0068315	*C0068316	*C0068081	
	90 Violet			C0068083					
 <b>HRC 20s</b>	70 Violet					*C0068785			
	70 Violet			*C0068325	C0068326	*C0068331	*C0068332	*C0068333	
 <b>HRC 22</b>	70 Violet								
	70 Incolore							*C0069475	
 <b>HRC 26</b>	70 Violet			C0068694	C0068335N1	C0068336N1	C0068343		
	90 Incolore						*C0069778		
 <b>HRC 26s</b>	70 Violet					C0068441	*C0068721	*C0068444	
	70 Incolore							C0069444	
 <b>HRC 30</b>	70 Violet				*C0068373	C0068372N1	C0068371	C0068374	
	70 90 Violet				C0068360 C0068139	C0068361N1 C0068140N1	C0068362 C0068141N1	C0068363 C0068142N1	B0068143

\* Fabrication spéciale. Délai d'approvisionnement minimum : 8 à 12 semaines.



Aiguille longueur mm	Fil longueur cm couleur	USP métrique								
		6/0 0,7	5/0 1	4/0 1,5	3/0 2	2/0 3	0 3,5	1 4	2 5	
Aiguille ronde micropointe 1/2 cercle										
 HRC 37s	70								C0068844	
	90 Violet									B0068897
	90 Incolore						*C0069004	*B0069886		
 HRC 40	70					*C0068908	*C0068909			
	90 Violet					*C0068949	*B0068950	C0068951		
	70 90 Incolore					*C0069920	*C0069903			
 HRC 40SS	70 Incolore					*C0069010				
 HRC 43	90 Violet						*C0068977			
 HRC 43s	90 Violet							C0068982	*B0068983	

\* Fabrication spéciale. Délai d'approvisionnement minimum : 8 à 12 semaines.





Aiguille longueur mm	Fil longueur cm couleur	USP métrique							
		6/0 0,7	5/0 1	4/0 1,5	3/0 2	2/0 3	0 3,5	1 4	2 5
Aiguille ronde micropointe 3/8 cercle									
 <b>DRC 12</b>	70 Violet	*C0068300	*C0068301	C0068302					
 <b>DRC 18</b>	70 Violet			*C0068460	*C0068468				
 <b>DRC 22</b>	70 Violet				*C0068827				
 <b>DRC 26</b>	70 Violet					*C0068317			
 <b>DRC 32</b>	70 Violet					*C0068322	*C0068324		

Aiguille ronde micropointe composite / progressive									
 <b>PRC 24</b>	120 Violet					*C0068807			
Aiguille ronde diamant 1/2 cercle									
 <b>HRT 37</b>	90 Incolore				C0069661				

\* Fabrication spéciale. Délai d'approvisionnement minimum : 8 à 12 semaines.

Aiguille longueur mm	Fil longueur cm couleur	USP métrique							
		6/0 0,7	5/0 1	4/0 1,5	3/0 2	2/0 3	0 3,5	1 4	2 5
Aiguille ronde diamant 1/2 cercle									
 <b>HRT 40s</b>	70 Incolore								C0069670
 <b>HRT 48</b> Boucle	150 Violet						*B0068369		

\* Fabrication spéciale. Délai d'approvisionnement minimum : 8 à 12 semaines.

Aiguille longueur mm	Fil longueur cm couleur	USP métrique								
		6/0 0,7	5/0 1	4/0 1,5	3/0 2	2/0 3	0 3,5	1 4	2 5	
Aiguille ronde diamant 3/8 cercle										
	70 Violet			*C0068376						
Aiguille ronde mousse 1/2 cercle										
	90 Violet					*C0068617	*C0068618	*C0068619		
	70 90 Incolore				*C0069550	*C0069549				
	90 Violet						*C0068636	C0068637		
	90 Violet							C0068647	*B0068648	
	90 Violet						*C0068663	*C0068664		







\* Fabrication spéciale. Délai d'approvisionnement minimum : 8 à 12 semaines.





# Novosyn®

Combinaison fil-aiguille







Aiguille longueur mm	Fil longueur cm couleur	USP métrique							
		6/0 0,7	5/0 1	4/0 1,5	3/0 2	2/0 3	0 3,5	1 4	2 5
Aiguille triangulaire (tranchante sur l'extérieur) 1/2 cercle									
 HS 15	70 Violet		*C0068233	*C0068250					
	45 Incolore		C0069203	*C0069204					
 HS 18	70 Violet							*C0068205	
	70 Incolore			*C0069322					
 HS 23	70 Violet				C0068430N1	C0068431N1	*C0068432		*C0068429
	70 Incolore				*C0069430	C0069431	*C0069432	*C0069433	
 HS 26	70				C0068241N1	C0068242N1	C0068243	*C0068244	
	90 Violet					*C0068442			
 HS 30	70					C0068251N1	C0068252N1	C0068253	
	90 Violet							*C0068493	
 HS 37	90 Violet				C0068494	C0068495N1	C0068496N1	C0068497N1	B0068498
	90 Incolore					*C0069294	C0069295	*C0069296	*B0069297
 HS 37s	90 Violet					C0068596N1	C0068582N1	C0068583N1	B0068599
	70 Incolore				*C0069460	C0069195	*C0069196	C0069197	



\* Fabrication spéciale. Délai d'approvisionnement minimum : 8 à 12 semaines.



Aiguille longueur mm	Fil longueur cm couleur	USP métrique								
		6/0 0,7	5/0 1	4/0 1,5	3/0 2	2/0 3	0 3,5	1 4	2 5	
Aiguille triangulaire (tranchante sur l'extérieur) 1/2 cercle										
 HS 40	90						C0068485	C0068486N1	C0068487N1	B0068488
	Violet									
 HS 40s	90						*C0068585	C0068586N1	C0068587N1	B0068588
	Violet									
 HS 48	70						*C0068691	C0068261	C0068262	C0068263
	90							C0068461	C0068462N1	B0068463
	Violet									
	90							C0069362	C0069363	B0069364
	Incolore									

\* Fabrication spéciale. Délai d'approvisionnement minimum : 8 à 12 semaines.









Aiguille longueur mm	Fil longueur cm couleur	USP métrique								
		6/0 0,7	5/0 1	4/0 1,5	3/0 2	2/0 3	0 3,5	1 4	2 5	
Aiguille triangulaire (tranchante sur l'extérieur) 3/8 cercle										
<b>DS 12</b> 	45	C0068206								
	70 Violet	*C0068506	*C0068507	C0068508						
	45	*C0069206	*C0069207	C0069208						
	Incolore									
<b>2xDS 12</b> 	45 Violet	*C0068706	*C0068769							
<b>DS 16</b> 	45 70 Violet		C0068212 C0068512	C0068513	C0068514					
	45 Incolore		*C0069212	C0069213	*C0069214					
<b>DS 19</b> 	70 Violet		*C0068419	C0068420N1	C0068421N1	C0068422N1				
	70 Incolore		*C0069419	C0069420N1	C0069421N1	*C0069422				
<b>DS 24</b> 	70 Violet		*C0068232	C0068234N1	C0068235N1	C0068236N1	C0068237N1			
	70 Incolore			*C0069234	C0069235N1	C0069236N1	*C0069237			

\* Fabrication spéciale. Délai d'approvisionnement minimum : 8 à 12 semaines.

Aiguille longueur mm	Fil longueur cm couleur	USP métrique								
		6/0 0,7	5/0 1	4/0 1,5	3/0 2	2/0 3	0 3,5	1 4	2 5	
Aiguille triangulaire (tranchante sur l'extérieur) 3/8 cercle										
 <b>DS 30</b>	70 Violet				C0068246N1	C0068247N1	C0068248N1	C0068249		
	70 Incolore				*C0069246	C0069247N1	C0069248			
 <b>DS 35</b>	70 Violet						*C0068257			
	70 Incolore					C0069256				
 <b>DS 48</b>	70 Incolore									*C0069282

Aiguille longueur mm	Fil longueur cm couleur	USP métrique								
		8/0 0,4	6/0 0,7	5/0 1	4/0 1,5	3/0 2	2/0 3	0 3,5	1 4	
Aiguille triangulaire droite										
 <b>GS 51</b>	70 Violet					*C0068272	*C0068274	*C0068275		
	70 Incolore				*C0069271	*C0069272	*C0069273			
 <b>GS 60</b>	70 Violet					C0068265	C0068266			
	70 Incolore					C0069265	*C0069267			
 <b>GS 75</b>	70 Violet									*G0068924

\* Fabrication spéciale. Délai d'approvisionnement minimum : 8 à 12 semaines.

Aiguille longueur mm	Fil longueur cm couleur	USP métrique							
		8/0 0,4	7/0 0,5	6/0 0,7	5/0 1	4/0 1,5	3/0 2	2/0 3	0 3,5
Aiguille triangulaire avec pointe de précision (tranchante sur l'extérieur) 3/8 cercle									
<b>DSMP 11</b> 	45 Violet		*C0068684	*C0068685					
	45 Incolore			C0069607	*C0069608				
<b>2xDSMP 11</b> 	45 Violet			*C0068726					
<b>DSMP 13</b> 	70 Violet				*C0068723				
	45 Incolore			*C0069618	C0069619	C0069620			
<b>2xDSMP 13</b> 	45 Violet				*C0068162				
	45 Incolore				*C0069715	C0069716			
<b>DSMP 16</b> 	45			*C0069526	*C0069525	C0069524	*C0069599		
	70 Incolore				*C0069325	C0069326	*C0069327		
<b>DSMP 19</b> 	70 Violet					C0068823	C0068824N1		
	45					C0069629N1	C0069630N1		
	70 Incolore				*C0069528	C0069529N1	C0069530N1		
<b>DSMP 24</b> 	70 Violet						*C0068864	C0068865N1	
	70 Incolore					*C0069555	C0069556N1	C0069554N1	
<b>DSMP 30</b> 	70 Violet						*C0068669	*C0068670	*C0068671

\* Fabrication spéciale. Délai d'approvisionnement minimum : 8 à 12 semaines.

C Boîte de 36	B Boîte de 24	G Boîte de 12	M Boîte de 6
---------------	---------------	---------------	--------------

## Combinaison fil-aiguille

Aiguille longueur mm	Fil longueur cm couleur	USP métrique							
		6/0 0,7	5/0 1	4/0 1,5	3/0 2	2/0 3	0 3,5	1 4	2 5
Aiguille ronde 1/2 cercle - Noire									
HR 17b 	70 Violet		*C0068144	C0068147	*C0068152				
HR 22b 	70 Violet			*C0068181	C0068186N1	*C0068189			
HR 26b 	70 Violet			*C0068196	C0068198N1	C0068209N1			
2xHR 26b 	70 Violet				*C0068210	C0068217			
Aiguille ronde 3/8 cercle - Noire									
DR 22b 	70 Violet			C0068108	C0068117				
Sutures pré-coupées - Brins et bobines									
6 fils de 45 cm	6 x 45 Violet		C0058643	C0058644	C0058645	C0058646	B0058647	B0058649	
5 fils de 70 cm	5 x 70 Violet			C0058444	C0058445	C0058446	C0058447	B0058449	B0058450
	5 x 70 Incolore				C0059445	C0059446	C0059447		
Bobines	1 x 250 Violet				G0058715	G0058716	G0058717	G0058719	G0058720
	1 x 250 Incolore				*G0059715	*G0059716	*G0059717		

\* Fabrication spéciale. Délai d'approvisionnement minimum : 8 à 12 semaines.

# Novosyn<sup>®</sup> CHD

Tresse synthétique résorbable enduite au diacétate de chlorexidine

## Description

Novosyn<sup>®</sup> CHD est une tresse résorbable synthétique à base d'acide polyglycolique et d'acide L-Lactique dans la proportion 90/10, enduite au diacétate de chlorexidine, disponible en violet et en incolore. Le diacétate de chlorexidine permet de réduire le risque de d'adhésion et de croissance bactérienne sur la suture

Novosyn<sup>®</sup> CHD est indiqué pour le rapprochement des tissus mous dans les applications où la pratique chirurgicale requiert l'utilisation de tresses résorbables et synthétiques.

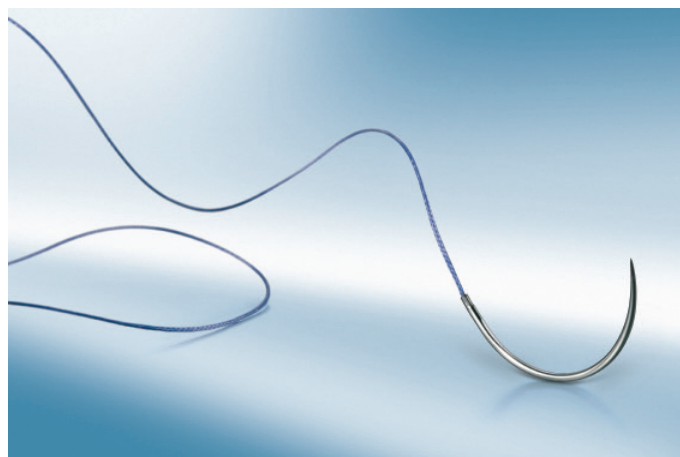

## Propriétés

- Résorption complète en 56 à 70 jours

## Indications

- Chirurgie générale et digestive
- Chirurgie gynécologique / obstétrique
- Chirurgie urologique
- Fermetures cutanées et sous-cutanées
- Chirurgie orthopédique





### Aperçu produit :

Structure	Tresse 
Couleur	Violet ou Incolore
Composition chimique	Acide polyglycolique / acide L-lactique (90/10)
Enduction	Acide polyglycolique / acide L-lactique / Stéarate de calcium + Diacétate de chlorexidine
Origine	Synthétique
Calibres	USP 5/0 - 2 (Déc. 1- 5)
Résorption	Résorption par hydrolyse
Stérilisation	Oxyde d'Ethylène

# Novosyn<sup>®</sup> CHD

Combinaison fil-aiguille



Aiguille longueur mm	Fil longueur cm couleur	USP métrique							
		6/0 0,7	5/0 1	4/0 1,5	3/0 2	2/0 3	0 3,5	1 4	2 5
Aiguille ronde 1/2 cercle									
 <b>HR 22</b>	70			C1068029					
	Violet								
 <b>HR 22s</b>	70							C1068038	
	Violet								
 <b>HR 26</b>	70				C1068041				
	90							C1068544	
	Violet								
Aiguille longueur mm	Fil longueur cm couleur	USP métrique							
		5/0 1	4/0 1,5	3/0 2	2/0 3	0 3,5	1 4	2 5	3 6
Aiguille ronde 1/2 cercle									
 <b>HR 30</b>	70				C1068047				
	Violet								



C Boîte de 36	B Boîte de 24	G Boîte de 12	M Boîte de 6
---------------	---------------	---------------	--------------





# Novosyn® CHD

Combinaison fil-aiguille



Aiguille longueur mm	Fil longueur cm couleur	USP métrique								
		6/0 0,7	5/0 1	4/0 1,5	3/0 2	2/0 3	0 3,5	1 4	2 5	
Aiguille ronde 3/8 cercle										
 DR 18	70 Violet			C1068150						
 DR 32	70 Violet					C1068171		C1068173		

Aiguille longueur mm	Fil longueur cm couleur	USP métrique								
		6/0 0,7	5/0 1	4/0 1,5	3/0 2	2/0 3	0 3,5	1 4	2 5	
Aiguille ronde micropointe 1/2 cercle										
 HRC 37	90 Violet					C1068140		B1068142		
 HRC 40	70 Violet						*C1068909			
 HRC 48	90 Violet								*B1068574	



\* Fabrication spéciale. Délai d'approvisionnement minimum : 8 à 12 semaines.



C Boîte de 36	B Boîte de 24	G Boîte de 12	M Boîte de 6
---------------	---------------	---------------	--------------

# Novosyn® CHD

Combinaison fil-aiguille



Aiguille longueur mm	Fil longueur cm couleur	USP métrique							
		6/0 0,7	5/0 1	4/0 1,5	3/0 2	2/0 3	0 3,5	1 4	2 5
Aiguille triangulaire (tranchante sur l'extérieur) 1/2 cercle									
 HS 26	70							C1068243	
	Violet								
 HS 37	90							B1068496	
	Violet								
 HS 48	90								B1068463
	Violet								
	90								B1069363
	Incolore								

Aiguille longueur mm	Fil longueur cm couleur	USP métrique							
		8/0 0,4	7/0 0,5	6/0 0,7	5/0 1	4/0 1,5	3/0 2	2/0 3	0 3,5
Aiguille triangulaire avec pointe de précision (tranchante sur l'extérieur) 3/8 cercle									
 DSMP 19	70						C1069529		
	Incolore								
 DSMP 24	70						C1069556	C1069554	
	Incolore								

Aiguille longueur mm	Fil longueur cm couleur	USP métrique							
		6/0 0,7	5/0 1	4/0 1,5	3/0 2	2/0 3	0 3,5	1 4	2 5
Bobines									
1 fil de 250 cm	1 x 250 Violet						G1058716	G1058717	G1058720

\* Fabrication spéciale. Délai d'approvisionnement minimum : 8 à 12 semaines.

C Boîte de 36	B Boîte de 24	G Boîte de 12	M Boîte de 6
---------------	---------------	---------------	--------------

# Monosyn® Quick

Monofilament synthétique résorbable à court terme

## Description

Monosyn® Quick est un monofilament synthétique résorbable à court terme composé de glyconate, disponible en incolore. Monosyn® Quick est indiqué dans le rapprochement des tissus mous à cicatrisation rapide.

## Propriétés

- Conserve 70 à 80 % de sa résistance initiale après 5 jours
- Résorption complète en 56 jours

## Indications

- Pédiatrie
- Gynécologie / obstétrique
- Urologie
- Maxillo-faciale et ORL
- Sutures dermiques









## Aperçu produit :

Structure	Monofilament
Couleur	Incolore
Composition chimique	Glyconate (72% glycolide, 14% carbonate de triméthylène, 14% e-caprolactone)
Enduction	Non enduit
Origine	Synthétique
Calibres	USP 6/0 (Déc. 0,7) à USP 1 (Déc. 4)
Résorption	Résorption par hydrolyse
Stérilisation	Oxyde d'Ethylène

# Monosyn<sup>®</sup> Quick

Combinaison fil-aiguille













Aiguille longueur mm	Fil longueur cm couleur	USP métrique							
		6/0 0,7	5/0 1	4/0 1,5	3/0 2	2/0 3	0 3,5	1 4	2 5
Aiguille ronde 1/2 cercle									
 HR 17	70 Incolore		C0025051	C0025052	C0025053				
 HR 22	45 Incolore				C0025160				
 HR 26	70 Incolore			C0025057	C0025058	C0025059			
 HR 37s	70 Incolore				C0025064	C0025065	C0025066	C0025067	
 HR 48	90 Incolore						C0025087	C0025088	
Aiguille ronde 1/2 cercle									
 HRT 37	90 Incolore						C0025091	C0025092	C0025093
 HRT 43	90 Incolore							C0025284	C0025285

# Monosyn<sup>®</sup> Quick

Combinaison fil-aiguille



Aiguille longueur mm	Fil longueur cm couleur	USP métrique							
		6/0 0,7	5/0 1	4/0 1,5	3/0 2	2/0 3	0 3,5	1 4	2 5
Aiguille triangulaire (tranchante sur l'extérieur) 1/2 cercle									
 HS 23	45 Incolore			C0025388	C0025389				
Aiguille triangulaire (tranchante sur l'extérieur) 3/8 cercle									
 DS 16	70 Incolore		C0025331	C0025332	C0025333				
 DS 19	70 Incolore	C0025005	C0025006	C0025007	C0025008				
 DS 24	70 Incolore			C0025011	C0025012	C0025013	C0025342		
 DS 30	70 Incolore				C0025014	C0025015			
Aiguille triangulaire pointe de précision (tranchante sur l'extérieur) 3/8 cercle									
 DSMP 11	45 Incolore	C0025020	C0025021						
 DSMP 13	45 Incolore	C0025023	C0025024	C0025025					
 DSMP 16	45 Incolore		C0025028	C0025029	C0025030				
 DSMP 19	70 Incolore			C0025036	C0025037	C0025038			
 DSMP 24	70 Incolore			C0025042	C0025043	C0025044			

C Boîte de 36	B Boîte de 24	G Boîte de 12	M Boîte de 6
---------------	---------------	---------------	--------------



# Monosyn®

## Monofilament synthétique résorbable à moyen terme

### Description

Monosyn® est un monofilament synthétique résorbable composé de glyconate, disponible en incolore pour la fermeture des plaies superficielles et en violet pour les autres indications.

### Propriétés

- Conserve 50% de sa résistance initiale après 14 jours
- Résorption complète en 60 à 90 jours











### Indications

- Chirurgie digestive
- Gynécologie / obstétrique
- Sutures sous-cutanées et intracutanées



### Aperçu produit :









Structure	Monofilament 
Couleur	Violet ou incolore
Composition chimique	Glyconate (72% glycolide, 14% carbonate de triméthylène, 14% e-caprolactone)
Enduction	Non enduit
Origine	Synthétique
Calibres	USP 7/0 (Déc. 0,5) à USP 2 (Déc. 5)
Résorption	Résorption par hydrolyse
Stérilisation	Oxyde d'Ethylène

Aiguille longueur mm	Fil longueur cm couleur	USP métrique							
		7/0 0,5	6/0 0,7	5/0 1	4/0 1,5	3/0 2	2/0 3	0 3,5	1 4
Aiguille ronde 1/2 cercle									
 HR 13	70 Violet		C0022007	C2022008					
 HR 17	70 Violet		C0022002	C2022003	C2022004	C2022005			
 2xHR 17	70 Violet			C0022803	*C0022804	*C0022805			
 HR 22	70 Violet				C2022014	C2022015	C2022016		
 2xHR 22	70 90 Violet				*C0022814 C0022914	*C0022815 C0022915			
longueur mm	longueur cm couleur	6/0 0,7	5/0 1	4/0 1,5	3/0 2	2/0 3	0 3,5	1 4	2 5
Aiguille ronde 1/2 cercle									
 HR 26	70 90 Violet			C2022024	C2022025	C2022026	C2022027		
 2xHR 26	70 90 Violet		*C0022423	C2022422	C2022425	C2022426			
 HR 26s	90 Violet				*C0022485	*C0022486	*C0022487	*C0022488	
 HR 30	70 Violet				C2022035	C2022036	C2022037		
 HR 37	70 Violet			C0022044	C2022045	C2022046	C2022047	C2022048	
 HR 37s	90 violet					C2022456	C2022457	C2022458	

\* Fabrication spéciale. Délai d'approvisionnement minimum : 8 à 12 semaines.

C Boîte de 36	B Boîte de 24	G Boîte de 12	M Boîte de 6
---------------	---------------	---------------	--------------







Aiguille longueur mm	Fil longueur cm couleur	USP métrique							
		6/0 0,7	5/0 1	4/0 1,5	3/0 2	2/0 3	0 3,5	1 4	2 5
Aiguille ronde 1/2 cercle									
	90 Violet					C0022466	C2022467	C2022468	B0022469
Aiguille longueur mm	Fil longueur cm couleur	USP métrique							
		7/0 0,5	6/0 0,7	5/0 1	4/0 1,5	3/0 2	2/0 3	0 3,5	1 4
Aiguille ronde 3/8 cercle									
	70 Violet		*C0022095	C0022096					
	70 Violet			C0022093	C2022094				
	70 Violet					C2022100			
	70 Violet					*C0022117	C2022118		
	70 Violet						*C0022106	*C0022125	
Aiguille ronde 5/8 cercle									
	70 Violet					C0022619	C2022620	C2022621	
	70 90 Violet				C0022734	C0022735	*C0022736 *C0022740		

\* Fabrication spéciale. Délai d'approvisionnement minimum : 8 à 12 semaines.





# Monosyn®

Combinaison fil-aiguille



Aiguille longueur mm	Fil longueur cm couleur	USP métrique								
		7/0 0,5	6/0 0,7	5/0 1	4/0 1,5	3/0 2	2/0 3	0 3,5	1 4	
Aiguille ronde 5/8 cercle										
	90 Violet					*C0022729	*C0022730			
	90 Violet								*C0022670	
Aiguille ronde ski										
	120 Violet					C0022717	*C0022718			
Aiguille longueur mm	Fil longueur cm couleur	USP métrique								
		6/0 0,7	5/0 1	4/0 1,5	3/0 2	2/0 3	0 3,5	1 4	2 5	
Aiguille ronde micropointe 3/8 cercle										
	70 Violet	*C0022392	*C0022403							

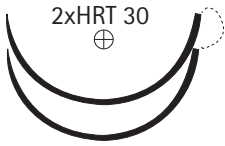





\* Fabrication spéciale. Délai d'approvisionnement minimum : 8 à 12 semaines.

Aiguille longueur mm	Fil longueur cm couleur	USP métrique								
		6/0 0,7	5/0 1	4/0 1,5	3/0 2	2/0 3	0 3,5	1 4	2 5	
Aiguille ronde pointe diamant 1/2 cercle										
	70 Violet	C0022310								
	70 Violet	C0022322	C0022323	C0022324						
	70 Violet			*C0022304	C2022305	C2022306				
	70 Violet				*C0022440	*C0022441				
	90 Violet					C2022516	*C0022517	*C0022518		

# Monosyn®

Combinaison fil-aiguille



Aiguille longueur mm	Fil longueur cm couleur	USP métrique								
		6/0 0,7	5/0 1	4/0 1,5	3/0 2	2/0 3	0 3,5	1 4	2 5	
Aiguille triangulaire (tranchante sur l'extérieur) 1/2 cercle										
HS 18 	70 Incolore		*C0023263	C0023264						
HS 23 	70 Incolore			*C0023224	C2023225	*C0023226				
HS 26 	70 Incolore				C0023239	*C2023240				
HS 30 	70 Incolore					*C0023250	*C0023251			
HS 37 	70 Incolore				*C0023235	C2023236	*C0023237	*C0023238		
HS 40 	90 Incolore						*C0023247	*C0023248		
HS 48 	90 Incolore						*C0023259	*C0023258		

\* Fabrication spéciale. Délai d'approvisionnement minimum : 8 à 12 semaines.

# Monosyn®

Combinaison fil-aiguille









Aiguille longueur mm	Fil longueur cm couleur	USP métrique							
		6/0 0,7	5/0 1	4/0 1,5	3/0 2	2/0 3	0 3,5	1 4	2 5
Aiguille triangulaire (tranchante sur l'extérieur) 3/8 cercle									
<b>DS 12</b> 	70 Incolore	C2023412	C2023413	C2023414					
<b>DS 16</b> 	70 Incolore		C2023423	C2023424	C2023425				
<b>DS 19</b> 	70 Incolore		C2023403	C2023404	C2023405				
<b>DS 24</b> 	70 Incolore			C2023214	C2023215	C2023216	*C0023181		
<b>DS 30</b> 	70 Incolore				C0023435	C2023436	*C0023437		

\* Fabrication spéciale. Délai d'approvisionnement minimum : 8 à 12 semaines.

# Monosyn®

Combinaison fil-aiguille



Aiguille longueur mm	Fil longueur cm couleur	USP métrique							
		7/0 0,5	6/0 0,7	5/0 1	4/0 1,5	3/0 2	2/0 3	0 3,5	1 4
Aiguille ronde droite									
<b>GS 51</b> 	70 Incolore				*C0023279	C0023280	*C0023281		
<b>GS 60</b> 	70 Incolore				C0023284	C2023285	C0023286		
Aiguille triangulaire pointe de précision (tranchante sur l'extérieur) 3/8 cercle									
<b>DSMP 11</b> 	45 Incolore		C2023642	C2023643					
<b>DSMP 13</b> 	45 Incolore		C0023602	C2023603	C2023604	*C0023605			
<b>DSMP 16</b> 	45 70 Incolore			C2023613	C2023614 C2023163				
<b>DSMP 19</b> 	45 70 Incolore			C2023623	C2023624 C2023627	C2023625 C2023628			
<b>DSMP 24</b> 	45 70 Incolore				C2023634 C2023632	C2023633 C2023635	C0023637 C2023636		

\* Fabrication spéciale. Délai d'approvisionnement minimum : 8 à 12 semaines.

# Monosyn®

## Combinaison fil-aiguille



Aiguille longueur mm	Fil longueur cm couleur	USP métrique							
		6/0 0,7	5/0 1	4/0 1,5	3/0 2	2/0 3	0 3,5	1 4	2 5
Aiguille ronde 1/2 cercle - Noire									
HR 13b 	70 Violet	C0022301							
HR 17b 	70 Violet		C0022616	C0022688	C0022689				
HR 22b 	70 Violet			C2022659	C2022660	C0022661			
2xHR 22b 	70 90 Violet			C0022632 C0022638	C0022639				
HR 26b 	70 Violet			C0022643	C2022357	C0022358			
2xHR 26b 	70 90 Violet				C0022649 C0022650	C0022654			

Aiguille longueur mm	Fil longueur cm couleur	USP métrique							
		7/0 0,5	6/0 0,7	5/0 1	4/0 1,5	3/0 2	2/0 3	0 3,5	1 4
Bobines									
1 fil de 250 cm	1 x 250 Violet						G0020046	G0020047	*G0020048
	1 x 250 Incolore						*G0021246	*G0021247	

\* Fabrication spéciale. Délai d'approvisionnement minimum : 8 à 12 semaines.

C Boîte de 36	B Boîte de 24	G Boîte de 12	M Boîte de 6
---------------	---------------	---------------	--------------

# MonoPlus®

## Monofilament synthétique résorbable à long terme

### Description

MonoPlus® est un monofilament synthétique résorbable, composé de polydioxanone. De par son profil de dégradation à long terme, MonoPlus® est indiqué pour toutes les indications où un maintien tissulaire prolongé (jusqu'à 4 semaines) est requis.

### Propriétés

- Conserve 50 à 70% de sa résistance initiale après 28 jours
- Résorption complète en 180 à 210 jours

### Indications

- Fermeture de la paroi abdominale
- Chirurgie cardiovasculaire pédiatrique



### Aperçu produit :

Structure	Monofilament
Couleur	Violet
Composition chimique	Polydioxanone
Enduction	Non enduit
Origine	Synthétique
Calibres	USP 7/0 (Déc. 0,5) à USP 2 (Déc. 5)
Résorption	Résorption par hydrolyse
Stérilisation	Oxyde d'Ethylène

# MonoPlus®

Combinaison fil-aiguille



Aiguille longueur mm	Fil longueur cm couleur	USP métrique							
		6/0 0,7	5/0 1	4/0 1,5	3/0 2	2/0 3	0 3,5	1 4	2 5
Aiguille ronde 1/2 cercle									
<b>HR 13</b> 	70 Violet	C0024002	C0024003	C0024004					
<b>2xHR 13</b> 	70 Violet	C0024602	C0024603						
<b>HR 13ss</b> 	70 Violet					*C0024206	*C0024207		
<b>HR 17</b> 	70 Violet	C0024012	C0024013	C0024014	C0024015				
<b>2xHR 17</b> 	70 Violet		C0024613	C0024614					
<b>HR 20</b> 	70 Violet			*C0024679	*C0024680				
<b>HR 22</b> 	70 Violet		C0024133	C2024134	C2024135	C0024136			
<b>2xHR 22</b> 	70 Violet			C0024634	C0024635				
<b>HR 26</b> 	70 Violet			C2024024	C2024025	C2024026	C2024027		









\* Fabrication spéciale. Délai d'approvisionnement minimum : 8 à 12 semaines.



# MonoPlus®

Combinaison fil-aiguille



Aiguille longueur mm	Fil longueur cm couleur	USP métrique								
		6/0 0,7	5/0 1	4/0 1,5	3/0 2	2/0 3	0 3,5	1 4	2 5	
Aiguille ronde 1/2 cercle										
	70 90 Violet			C0024624 C0024437	C0024625 C0024438	C0024626 *C0024441				
	70 Violet			C2024034	C2024035	C2024036	C2024037	*C0024038		
	70 90 Violet				C0024045	C2024046	C2024447	C0024448		
	90 Violet							C0024458		
	70 90 Violet						C0024067 C2024467	C2024068 C2024468	*B0024469	
 Boucle	150 Violet						B0024567	B0024568		
	90 Violet							C2024078	B0024079	
 Boucle	150 Violet						B0024090	B0024091		
 Boucle	150 Violet							B0024098		

\* Fabrication spéciale. Délai d'approvisionnement minimum : 8 à 12 semaines.

# MonoPlus®

Combinaison fil-aiguille



Aiguille longueur mm	Fil longueur cm couleur	USP métrique							
		7/0 0,5	6/0 0,7	5/0 1	4/0 1,5	3/0 2	2/0 3	0 3,5	1 4
Aiguille ronde 3/8 cercle									
<b>2xDR 10</b> 	70 Violet	C0024801	*C0024802						
<b>DR 12</b> 	70 Violet		C0024512	C0024513					
<b>2xDR 12</b> 	70 Violet		C0024812	C0024813	C0024814				
<b>DR 15</b> 	70 Violet			*C0024523	*C0024524	*C0024525			
<b>2xDR 15</b> 	70 Violet			*C0024823	*C0024824	*C0024825			
<b>DR 18</b> 	70 Violet			*C0024533	*C0024534				
<b>2xDR 18</b> 	70 Violet			*C0024833	*C0024834				
Aiguille ronde droite									
<b>2xGR 19</b> 	45 Violet				*C0024984	*C0024985			





\* Fabrication spéciale. Délai d'approvisionnement minimum : 8 à 12 semaines.

C Boîte de 36	B Boîte de 24	G Boîte de 12	M Boîte de 6
---------------	---------------	---------------	--------------

# MonoPlus®

Combinaison fil-aiguille



Aiguille longueur mm	Fil longueur cm couleur	USP métrique							
		7/0 0,5	6/0 0,7	5/0 1	4/0 1,5	3/0 2	2/0 3	0 3,5	1 4
Aiguille ronde micropointe 3/8 cercle									
<b>2xDRC 10</b> 	70 Violet	*C0024721	*C0024722						
<b>DRC 12</b> 	70 Violet		*C0024232	*C0024233					
<b>2xDRC 12</b> 	70 Violet		*C0024732	*C0024733					
Aiguille ronde micropointe composite/progressive									
<b>PRC 24</b> 	120 Violet						*C0024850		









\* Fabrication spéciale. Délai d'approvisionnement minimum : 8 à 12 semaines.

C Boîte de 36	B Boîte de 24	G Boîte de 12	M Boîte de 6
---------------	---------------	---------------	--------------

# MonoPlus®

Combinaison fil-aiguille













Aiguille longueur mm	Fil longueur cm couleur	USP métrique							
		6/0 0,7	5/0 1	4/0 1,5	3/0 2	2/0 3	0 3,5	1 4	2 5
Aiguille ronde pointe diamant 1/2 cercle									
 <b>HRT 17</b>	70 Violet		*C0024283	C0024284	*C0024285	*C0024286			
 <b>HRT 22</b>	70 Violet			C0024294	C0024295				
 <b>HRT 26</b>	70 Violet			*C0024304	C2024305	C2024306			
 <b>HRT 37</b>	70 90 Violet					*C0024316	*C0024517	*C0024518	
 <b>HRT 40s</b>	90 Violet						*C0024545	C0024546	
 <b>HRT 40s</b> Boucle	150 Violet						B0024342	B0024343	
 <b>HRT 43s</b> Boucle	150 Violet							B0024347	
 <b>HRT 48</b>	90 Violet						*C0024332	C0024333	
 <b>HRT 48</b> Boucle	150 Violet						B0024394	B0024393	

\* Fabrication spéciale. Délai d'approvisionnement minimum : 8 à 12 semaines.

# MonoPlus®

Combinaison fil-aiguille



Aiguille longueur mm	Fil longueur cm couleur	USP métrique								
		6/0 0,7	5/0 1	4/0 1,5	3/0 2	2/0 3	0 3,5	1 4	2 5	
Aiguille ronde pointe mousse 1/2 cercle										
 HRN 50	90 Violet								*C0024408	
Aiguille triangulaire (tranchante sur l'extérieur) 1/2 cercle										
 HS 18	70 Violet			*C0024730						
 HS 23	70 Violet				*C0024190					
 HS 26s	70 Violet				C0024185	C2024186	C2024187	*C0024188		
 HS 30	70 Violet							*C0024195		
 HS 37	90 Violet						*C0024104	*C0024105	*C0024106	
 HS 37s	90 Violet						*C0024114	*C0024115	*C0024116	
 HS 40	90 Violet							*C0024117	C0024118	
 HS 40s	90 Violet						*C0024121	*C0024122		
 HS 48	90 Violet							*C0024127	*C0024128	





\* Fabrication spéciale. Délai d'approvisionnement minimum : 8 à 12 semaines.

C Boîte de 36	B Boîte de 24	G Boîte de 12	M Boîte de 6
---------------	---------------	---------------	--------------

# MonoPlus®

Combinaison fil-aiguille



Aiguille longueur mm	Fil longueur cm couleur	USP métrique							
		6/0 0,7	5/0 1	4/0 1,5	3/0 2	2/0 3	0 3,5	1 4	2 5
Aiguille triangulaire (tranchante sur l'extérieur) 3/8 cercle									
 <b>DS 16</b>	70 Violet		C0024535						
 <b>DS 19</b>	70 Violet			C2024536	C0024519				
 <b>DS 24</b>	70 Violet			C0024541	C2024520	C2024990			
 <b>DS 30</b>	70 Violet						*C0024598		
Aiguille triangulaire droite									
 <b>GS 60</b>	70 Violet			*C0024540	*C0024189				

Aiguille longueur mm	Fil longueur cm couleur	USP métrique							
		6/0 0,7	5/0 1	4/0 1,5	3/0 2	2/0 3	0 3,5	1 4	2 5
Sutures pré-coupées – Brins									
2 fils de 70 cm	2 x 70 Violet						*C0044200	*C0044205	

\* Fabrication spéciale. Délai d'approvisionnement minimum : 8 à 12 semaines.

# MonoPlus®

Combinaison fil-aiguille



Aiguille longueur mm	Fil longueur cm couleur	USP métrique								
		7/0 0,5	6/0 0,7	5/0 1	4/0 1,5	3/0 2	2/0 3	0 3,5	1 4	
Aiguille ronde 1/2 cercle - Noire										
HR 17b 	70 Violet			C0024515	C0024521					
HR 22b 	70 Violet				C2024522	C0024530				
2xHR 22b 	75 Violet				C0024531					
HR 26b 	70 Violet				C0024547	C2024548	C0024551			
Aiguille ronde 3/8 cercle - Noire										
DR 10b 	75 Violet	C0024010								
DR 13b 	75 Violet			C0024008						
DR 18b 	70 Violet				C0024611					

\* Fabrication spéciale. Délai d'approvisionnement minimum : 8 à 12 semaines.

C Boîte de 36	B Boîte de 24	G Boîte de 12	M Boîte de 6
---------------	---------------	---------------	--------------





# MonoMax<sup>®</sup>

Monofilament synthétique résorbable à très long terme

## Description

MonoMax<sup>®</sup> est un monofilament synthétique résorbable à très long terme, composé de Poly-4-hydroxybutyrate. Grâce à son profil de dégradation, MonoMax<sup>®</sup> fournit un soutien à la plaie tout au long du processus de cicatrisation de la paroi abdominale.

## Propriétés

- Conserve 40% de sa résistance initiale après 112 jours
- Résorption complète entre 13 et plus de 36 mois

## Indication

- Fermeture de la paroi abdominale

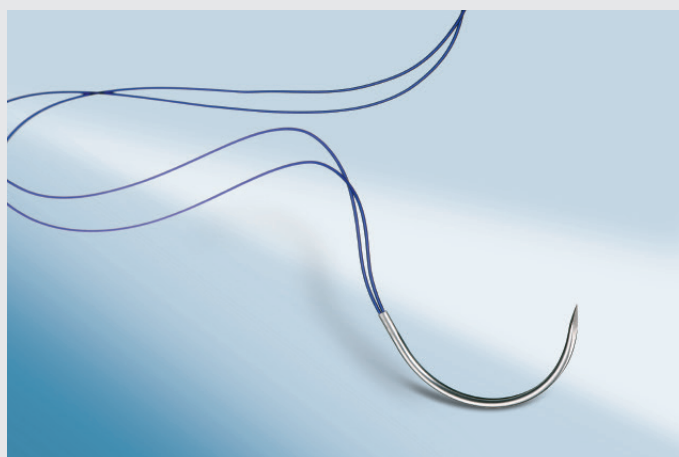









### Aperçu produit :

Structure	Monofilament
Couleur	Violet
Composition chimique	Poly-4-hydroxybutyrate
Enduction	Non enduit
Origine	Synthétique
Calibres	USP 2/0 (Déc. 3), USP 0 (Déc. 3,5) et USP 1 (Déc. 4)
Résorption	Par hydrolyse (réaction enzymatique)
Stérilisation	Oxyde d'Ethylène

# MonoMax<sup>®</sup>

Combinaison fil-aiguille









Aiguille longueur mm	Fil longueur cm couleur	USP métrique							
		5/0 1	4/0 1,5	3/0 2	2/0 3	0 3,5	1 4	2 5	3 6
Aiguille ronde 1/2 cercle									
 HR 26	90 Violet				B0041258				
 HR 30	90 Violet				*B0041278		*B0041280		
 HR 37	90 Violet					B0041024	B0041025		
 HR 40	70 90 Violet				B0041057	B0041066	B0041067		
 HR 40s	150 Violet					B0041076	B0041077		
 HR 48	90 Violet					B0041137	B0041138		
 HR 48	150 Violet					B0041118	B0041119		
 HR 65	150 Violet					B0041147	B0041148		

C Boîte de 36	B Boîte de 24	G Boîte de 12	M Boîte de 6
---------------	---------------	---------------	--------------

# MonoMax<sup>®</sup>

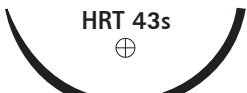
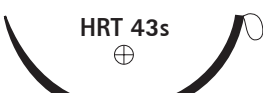
Combinaison fil-aiguille



Aiguille longueur mm	Fil longueur cm couleur	USP métrique								
		5/0 1	4/0 1,5	3/0 2	2/0 3	0 3,5	1 4	2 5	3 6	
Aiguille ronde pointe diamant 1/2 cercle										
 HRT 40 Boucle	70 Violet								*B0041344	
 HRT 40s Boucle	150 Violet					B0041184		B0041185		
 HRT 43s Boucle	90 Violet							B0041212		
 HRT 43s Boucle	150 Violet							B0041203		
 HRT 48 Boucle	90 Violet					B0041240		B0041241		
 HRT 48 Boucle	150 Violet					B0041221		B0041222		
Aiguille ronde pointe mousse 1/2 cercle										
 HRN 50 Boucle	150 Violet							B0041166		

\* Fabrication spéciale. Délai d'approvisionnement minimum : 8 à 12 semaines.

C Boîte de 36	B Boîte de 24	G Boîte de 12	M Boîte de 6
---------------	---------------	---------------	--------------



## Sutures non résorbables

---

Optilene®

---

PremiCron®

---

Dafilon®

---

Dagrofil®

---

Silkam®

---

Steelex®

---



# Optilene®

Monofilament synthétique non résorbable de polypropylène et polyéthylène

## Description

Optilene® est un monofilament non résorbable de polypropylène et polyéthylène, disponible en bleu pour améliorer la visibilité. Optilene® présente la particularité d'être disponible en conditionnement LongPack et RacePack®, et équipé pour certaines références de pledgets PremiPatch® en PTFE.

## Indications

















- Chirurgie cardio-vasculaire
- Neurochirurgie
- Ophtalmologie
- Microchirurgie
- Approximation des tissus mous



Aperçu Produit :	
Structure	Monofilament
Couleur	Bleu
Composition chimique	Polypropylène et polyéthylène
Enduction	Non enduit
Origine	Synthétique
Calibres	USP 10/0 (Déc. 0.2) à USP 2 (Déc. 5)
Résorption	Non résorbable
Stérilisation	Oxyde d'éthylène

# Optilene®

## Combinaison fil-aiguille

Aiguille		Fil	USP métrique							
longueur mm	diamètre microns		longueur cm couleur	10/0 (0.2)	9/0 (0.3)	8/0 (0.4)	7/0 (0.5)	6/0 (0.7)	5/0 (1)	4/0 (1.5)
Aiguille ronde de microchirurgie 3/8 cercle										
<b>DRm 4</b> 		10	G3090781*							
	135° 70µm	Bleu								
<b>DRm 5</b> 		15	G3090782							
	135° 100µm	Bleu								
<b>2xDRm 5</b> 		45	G3090482							
	135° 100µm	Bleu								
<b>DRm 6</b> 		15 45	G3090783							
	135°  140µm	Bleu								*G3090883
<b>2xDRm 6</b> 		45	G3090780							
	135°  140µm	Bleu								
<b>DRm 8</b> 		15 45	G3090753							
	135°  140µm	Bleu								
<b>2xDRm 8</b> 		60	G3090758							
	135°  140µm	Bleu								
<b>2xDRm 10b</b> 		45								
	 200µm	Bleu								*G3090610 *G3095149
<b>DRm 10b</b> 		75								
	135°  200µm	Bleu								*G3090784 *G3090785

 Conditionnement RacePack®

 Conditionnement LongPack



\* Fabrication spéciale. Délai d'approvisionnement minimum : 8 à 12 semaines.





C Boîte de 36	B Boîte de 24	G Boîte de 12	M Boîte de 6
---------------	---------------	---------------	--------------

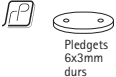

# Optilene®

## Combinaison fil-aiguille

Aiguille			Fil	USP métrique						
longueur mm	angle	diamètre microns	longueur cm couleur	10/0 (0.2)	9/0 (0.3)	8/0 (0.4)	7/0 (0.5)	6/0 (0.7)	5/0 (1)	4/0 (1.5)
Aiguille spatulée droite de microchirurgie										
<b>2xGLm 16</b>		150µm	23 Bleu	*G3095480	*G3095481					
Aiguille ronde 1/2 cercle										
<b>2xHR 10</b>			75 Bleu				C3097867	C3097868	*C3090869	
			60 Bleu						*C3095950	
<b>2xHR 13</b>			75 Bleu				*C3097060	C3090953	C3090954	
										

Aiguille			Fil	USP métrique						
longueur mm			longueur cm couleur	7/0 (0.5)	6/0 (0.7)	5/0 (1)	4/0 (1.5)	3/0 (2)	2/0 (3)	0 (3.5)
Aiguille triangulaire (tranchante sur l'extérieur) droite										
	<b>GS 51</b>		75 Bleu					*C3090284	*C3090285	
	<b>GS 60</b>		75 Bleu						C3090266	*C3090267
Aiguille triangulaire (tranchante sur l'extérieur) avec pointe de précision 3/8 cercle										
	<b>DSMP 11</b>		75 Bleu	*C3090406	*C3090407					
	<b>DSMP 13</b>		75 Bleu			*C3090409	*C3090410			









\* Fabrication spéciale. Délai d'approvisionnement minimum : 8 à 12 semaines.







 Conditionnement RacePack®

 Conditionnement LongPack

# Optilene®

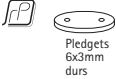
## Combinaison fil-aiguille

Aiguille longueur mm	Fil longueur cm couleur	USP métrique						
		6/0 (0.7)	5/0 (1)	4/0 (1.5)	3/0 (2)	2/0 (3)	0 (3.5)	1 (4)
Aiguille ronde 1/2 cercle								
	 75 Bleu		C3090501	C3090503	C3090502			
	*C3090898 90 Bleu	C3090901	C3090902	C3090903	*C3090900			
	  90 Bleu			*C3090837				
	  90 Bleu			*C3095327				
 	 90 Bleu		*C3095660	*C3095643				

Aiguille longueur mm	Fil longueur cm couleur	USP métrique						
		6/0 (0.7)	5/0 (1)	4/0 (1.5)	3/0 (2)	2/0 (3)	0 (3.5)	1 (4)
Aiguille ronde 1/2 cercle								
	 90 Bleu			C3090976	C3090977	C3090978		
	*C3090876 120 Bleu			*C3090876				
	  90 Bleu				*C3090979			
	  90 Bleu				*C3095336			
	 2 x 90 Bleu				*G3095620			











 Conditionnement RacePack®

 Conditionnement LongPack

\* Fabrication spéciale. Délai d'approvisionnement minimum : 8 à 12 semaines.

# Optilene®

## Combinaison fil-aiguille















Aiguille longueur mm	Fil longueur cm couleur	USP métrique							
		6/0 (0.7)	5/0 (1)	4/0 (1.5)	3/0 (2)	2/0 (3)	0 (3.5)	1 (4)	
Aiguille ronde 1/2 cercle									
 		75		C3090906	C3090707	C3090708	C3090087		
		90		*C3090905	C3090907	C3090908			
		120 Bleu			*C3095709	C3090709	*C3095710		
	  Pledgets 6x3mm durs	90 Bleu			C3090910	*C3090838			
	  Pledgets 6x3mm souples	90 Bleu			*C3095347				
 		75			C3090040	C3090041	C3090042	C3090043	

\* Fabrication spéciale. Délai d'approvisionnement minimum : 8 à 12 semaines.

C Boîte de 36	B Boîte de 24	G Boîte de 12	M Boîte de 6
---------------	---------------	---------------	--------------

# Optilene®

## Combinaison fil-aiguille

Aiguille longueur mm	Fil longueur cm couleur	USP métrique						
		6/0 (0.7)	5/0 (1)	4/0 (1.5)	3/0 (2)	2/0 (3)	0 (3.5)	1 (4)
Aiguille ronde 1/2 cercle								
 HR 30 	 75 Bleu				*C3090046			
	 75 Bleu						C3090047	C3090048
 2xHR 30 	 90 Bleu				C3090001	C3090002		
 HR 37 	 75 Bleu					C3090051	C3090052	C3090053
 2xHR 37  	 90 Bleu				C3090942	C3090943	*C3095054	

\* Fabrication spéciale. Délai d'approvisionnement minimum : 8 à 12 semaines.



 Conditionnement RacePack®

 Conditionnement LongPack

# Optilene®

## Combinaison fil-aiguille

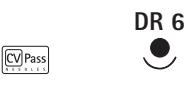
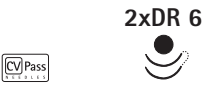
Aiguille longueur mm	Fil longueur cm couleur	USP métrique						
		5/0 (1)	4/0 (1.5)	3/0 (2)	2/0 (3)	0 (3.5)	1 (4)	2 (5)
Aiguille ronde 1/2 cercle								
 HR 40s Easyslide	75				*C3090033	C3090199	C3090200	
	Bleu							



Aiguille longueur mm	Fil longueur cm couleur	USP métrique						
		8/0 (0.4)	7/0 (0.5)	6/0 (0.7)	5/0 (1)	4/0 (1.5)	3/0 (2)	2/0 (3)
Aiguille ronde 3/8 cercle								
 DR 6 CVPass	45	*C3097110						
	Bleu							
 2xDR 6 CVPass	45	C3097880						
	60	C3097712	*C3097015					
	Bleu							
 Long pack	2 x 45	G3097841						
	Bleu							
 Easyslide	60	C3095669						
	Bleu							





\* Fabrication spéciale. Délai d'approvisionnement minimum : 8 à 12 semaines.

C Boîte de 36	B Boîte de 24	G Boîte de 12	M Boîte de 6
---------------	---------------	---------------	--------------

# Optilene®

## Combinaison fil-aiguille

Aiguille longueur mm	Fil longueur cm couleur	USP métrique							
		8/0 (0.4)	7/0 (0.5)	6/0 (0.7)	5/0 (1)	4/0 (1.5)	3/0 (2)	2/0 (3)	
Aiguille ronde 3/8 cercle									
 	    	45	*C3097703	*C3097685	*C3097686	*C3097684			
		60	C3097887	C3097888	C3097889				
		75	C3097004	C3097885	C3097886				
		Bleu							

Aiguille longueur mm	Fil longueur cm couleur	USP métrique							
		8/0 (0.4)	7/0 (0.5)	6/0 (0.7)	5/0 (1)	4/0 (1.5)	3/0 (2)	2/0 (3)	
Aiguille ronde 3/8 cercle									
 	   	60		C3097714	C3097715	*C3097522			
		75		C3097914	C3097915	C3097913			
		Bleu							
	   	75				*C3097306			
		Bleu							
		75				*C3095679			
Bleu									







\* Fabrication spéciale. Délai d'approvisionnement minimum : 8 à 12 semaines.

 Conditionnement RacePack®

 Conditionnement LongPack

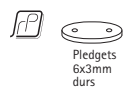
# Optilene®

## Combinaison fil-aiguille

Aiguille longueur mm	Fil longueur cm couleur	USP métrique						
		8/0 (0.4)	7/0 (0.5)	6/0 (0.7)	5/0 (1)	4/0 (1.5)	3/0 (2)	2/0 (3)
Aiguille ronde 3/8 cercle								
 	60		*C3097894	C3097895	*C3097896			
	75		*C3097905	C3097906	C3097907	*C3095908		
	75				*C3098173			
 	60			*C3097926	C3097609			
	75			C3097191	C3097547			
	75			*C3095667	*C3095687			

\* Fabrication spéciale. Délai d'approvisionnement minimum : 8 à 12 semaines.













 Conditionnement RacePack®

 Conditionnement LongPack

C Boîte de 36	B Boîte de 24	G Boîte de 12	M Boîte de 6
---------------	---------------	---------------	--------------

# Optilene®

## Combinaison fil-aiguille

Aiguille longueur mm	Fil longueur cm couleur	USP métrique							
		8/0 (0.4)	7/0 (0.5)	6/0 (0.7)	5/0 (1)	4/0 (1.5)	3/0 (2)	2/0 (3)	
Aiguille ronde 3/8 cercle									
  <b>DR 18</b>	 75  Bleu				*C3090119	C3090120	*C3095057		
  <b>2xDR 18</b>	 75  90  120  Bleu				C3090719	*C3090720			
									*C3095092
  <b>2xDR 22</b>	 75  90  120  Bleu					*C3090722	*C3090723	*C3090721	
							*C3090821	*C3090822	*C3090823
								*C3095114	
  <b>2xDR 26</b>	 75  Bleu						*C3090724	*C3090725	



\* Fabrication spéciale. Délai d'approvisionnement minimum : 8 à 12 semaines.







C Boîte de 36	B Boîte de 24	G Boîte de 12	M Boîte de 6
---------------	---------------	---------------	--------------



# Optilene®

## Combinaison fil-aiguille

Aiguille longueur mm	Fil longueur cm couleur	USP métrique						
		6/0 (0.7)	5/0 (1)	4/0 (1.5)	3/0 (2)	2/0 (3)	0 (3.5)	1 (4)
Aiguille ronde 5/8 cercle								
 	 75 Bleu						*C3095360	*C3090066

Aiguille longueur mm	Fil longueur cm couleur	USP métrique						
		7/0 (0.5)	6/0 (0.7)	5/0 (1)	4/0 (1.5)	3/0 (2)	2/0 (3)	0 (3.5)
Aiguille ronde micropointe 1/2 cercle								
 	 75 Bleu				*C3090472	*C3090473	C3090474	*C3095796
 	 75 90 120 Bleu				*C3095771	C3090820	*C3095140	
		 Pledgets 6x3mm souples					*C3095377	















\* Fabrication spéciale. Délai d'approvisionnement minimum : 8 à 12 semaines.

 Conditionnement  
RacePack®

 Conditionnement  
LongPack

# Optilene®

## Combinaison fil-aiguille





















Aiguille longueur mm	Fil longueur cm couleur	USP métrique						
		8/0 (0.4)	7/0 (0.5)	6/0 (0.7)	5/0 (1)	4/0 (1.5)	3/0 (2)	2/0 (3)
Aiguille ronde micropointe 3/8 cercle								
<b>2xDRC 6</b>   	45	*C3097209						
	60	*C3097246						
	Bleu							
<b>2xDRC 8</b>   	45	*C3097211	*C3097231					
	60	*C3097025	C3097046					
	2 x 60	*G3097178	*G3097179					
<b>DRC 10</b>   	75			C3097539				
	Bleu							
<b>2xDRC 10</b>   	45		*C3097548	*C3097553				
	60			*C3097543				
	75		C3097545	C3097546				
	Bleu							
<b>2xDRC 10b</b>   	60	*C3097462		C3097578				
	Bleu							

\* Fabrication spéciale. Délai d'approvisionnement minimum : 8 à 12 semaines.

C Boîte de 36	B Boîte de 24	G Boîte de 12	M Boîte de 6
---------------	---------------	---------------	--------------

# Optilene®





## Combinaison fil-aiguille









Aiguille longueur mm		Fil longueur cm couleur	USP métrique						
			8/0 (0.4)	7/0 (0.5)	6/0 (0.7)	5/0 (1)	4/0 (1.5)	3/0 (2)	2/0 (3)
Aiguille ronde micropointe 3/8 cercle									
	<b>DRC 13</b> 		75				*C3097144	*C3097145	*C3095531
			Bleu						
	<b>2xDRC 13</b> 		60				C3097271		
			75		*C3097301	C3097175	C3097141	*C3096165	
	<b>2xDRC 13b</b> 		75				*C3095673	*C3095671	
			Bleu						
	<b>2xDRC 13b</b> 		75				*C3097836	*C3097315	
			Bleu						
	<b>DRC 15</b> 		75				*C3095520	*C3095523	
			Bleu						
	<b>2xDRC 15</b> 		75				*C3095559	*C3095756	
			Bleu						
	<b>2xDRC 18</b> 		75				*C3095194	*C3095195	
			90				*C3090525	*C3090526	*C3090527
			Bleu						

\* Fabrication spéciale. Délai d'approvisionnement minimum : 8 à 12 semaines.

# Optilene®

## Combinaison fil-aiguille

Aiguille longueur mm	Fil longueur cm couleur	USP métrique						
		8/0 (0.4)	7/0 (0.5)	6/0 (0.7)	5/0 (1)	4/0 (1.5)	3/0 (2)	2/0 (3)
Aiguille ronde micropointe 3/8 cercle								
 2xDRC 22 	90					*C3090535	*C3090536	
	120					*C3095564		
	Bleu							
 2xDRC 26 	75					*C3095631	*C3095634	
	120					*C3095629	*C3095632	*C3095612
	Bleu							

Aiguille longueur mm	Fil longueur cm couleur	USP métrique						
		7/0 (0.5)	6/0 (0.7)	5/0 (1)	4/0 (1.5)	3/0 (2)	2/0 (3)	0 (3.5)
Aiguille triangulaire (tranchante sur l'extérieur) 1/2 cercle								
 HS 21 	75				*C3090460	*C3090461		
	Bleu							
 HS 26 	75					*C3090269	*C3090270	*C3090271
	Bleu							
 HS 30 	75					*C3090274	*C3090275	*C3090276
	Bleu							
 HS 37 	75						*C3090279	*C3090280
	Bleu							









 Conditionnement RacePack®







 Conditionnement LongPack

\* Fabrication spéciale. Délai d'approvisionnement minimum : 8 à 12 semaines.

# Optilene®

## Combinaison fil-aiguille













Aiguille		Fil	USP métrique							
longueur mm	longueur cm couleur		6/0 (0.7)	5/0 (1)	4/0 (1.5)	3/0 (2)	2/0 (3)	0 (3.5)	1 (4)	
Aiguille triangulaire (tranchante sur l'extérieur) 3/8 cercle										
	DS 12 		45 Bleu	*C3090206	*C3090207	*C3090208	*C3090205			
	DS 16 		75 Bleu		*C3090512	*C3090513	C3090514			
	DS 19 		75 Bleu		*C3090519	C3090520	C3090521	*C3095522		







Aiguille		Fil	USP métrique							
longueur mm	longueur cm couleur		5/0 (1)	4/0 (1,5)	3/0 (2)	2/0 (3)	0 (3,5)	1 (4)	2 (5)	
Aiguille triangulaire (tranchante sur l'extérieur) 3/8 cercle										
	DS 24 		75 Bleu			C3090235	C3090236	*C3090237	C3090238	
	DS 30 		75 Bleu		*C3090245	C3090246	C3090247	C3090248		

\* Fabrication spéciale. Délai d'approvisionnement minimum : 8 à 12 semaines.

# Optilene®

## Combinaison fil-aiguille

Aiguille longueur mm	Fil longueur cm couleur	USP métrique						
		7/0 (0.5)	6/0 (0.7)	5/0 (1)	4/0 (1.5)	3/0 (2)	2/0 (3)	0 (3.5)
<b>Aiguille triangulaire (tranchante sur l'extérieur) droite</b>								
 <b>GS 51</b> 	 75 Bleu					*C3090284	*C3090285	
 <b>GS 60</b> 	 75 Bleu						C3090266	*C3090267
<b>Aiguille triangulaire (tranchante sur l'extérieur) avec pointe de précision 3/8 cercle</b>								
 <b>DSMP 11</b> 	 75 Bleu	*C3090406	*C3090407					
 <b>DSMP 13</b> 	 75 Bleu			*C3090409	*C3090410			

Aiguille longueur mm	Fil longueur cm couleur	USP métrique						
		7/0 (0.5)	6/0 (0.7)	5/0 (1)	4/0 (1.5)	3/0 (2)	2/0 (3)	0 (3.5)
<b>Aiguille triangulaire (tranchante sur l'extérieur) avec pointe de précision 3/8 cercle</b>								
 <b>DSMP 16</b> 	 75 Bleu		*C3090428	*C3090429	*C3090427			
 <b>DSMP 19</b> 	 75 Bleu			*C3090672	C3090673	C3090674		

\* Fabrication spéciale. Délai d'approvisionnement minimum : 8 à 12 semaines.

 Conditionnement  
RacePack®

 Conditionnement  
LongPack

C Boîte de 36	B Boîte de 24	G Boîte de 12	M Boîte de 6
---------------	---------------	---------------	--------------

# PremiCron®

Tresse synthétique non résorbable de polyester  
enduit

## Description

PremiCron® est une tresse synthétique non résorbable de Polyester. Les sutures PremiCron® sont enduites avec du silicone.

Disponible en sachets individuels (1, 2 sutures) ou Multipacks (4, 8 sutures) en blanc ou vert.

■ Disponible sur des aiguilles : CV Pass et CV Pass Easyblack



## Indications

- Chirurgie cardiaque (Remplacement des valves cardiaques)
- Chirurgie générale
- Chirurgie vasculaire

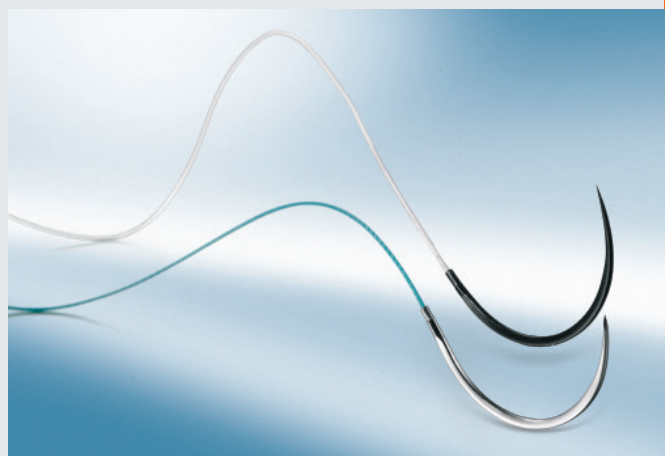

## Aperçu Produit :

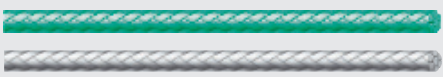
Structure	Tresse 
Couleur	Vert ou blanc
Composition chimique	Polyester
Enduction	Silicone
Origine	Synthétique
Calibres	USP 6/0 (Déc. 0,7) à USP 5 (Déc. 7)
Résorption	Non résorbable
Stérilisation	Irradiation Gamma Oxyde d'Ethylène (combinaisons avec pledgets PTFE)

# PremiCron®

Combinaison fil-aiguille



Aiguille			Fil	USP métrique						
longueur mm	angle	diamètre microns	longueur cm couleur	6/0 0,7	5/0 1	4/0 1,5	3/0 2	2/0 3	0 3,5	1 4
Aiguille spatulée micropointe 1/4 cercle										
	<b>2xVLM 8</b> 	90°	330 µ Blanc		G0027115					
Aiguille ronde 1/2 cercle										
	<b>HR 17</b> 		75 Vert		C0026003	C0026004	C0026005	C0026006		
			75 90 Vert		C2026903	C2026804 C2026904	C2026905	C2026806 C2026906		
	<b>2xHR 17</b> 		75 Blanc					C2027457		
			8 x 75 V/B					M0027775		
		  Pledgets 6x3 mm durs	8 x 75 V/B					M0027776		
	<b>HR 22</b> 		75 Vert			C0026024	C0026025	C0026026		

C Boîte de 36

B Boîte de 24

G Boîte de 12

M Boîte de 6



# PremiCron®

Combinaison fil-aiguille













Aiguille		Fil longueur cm couleur	USP métrique					
longueur mm	6/0 0,7		5/0 1	4/0 1,5	3/0 2	2/0 3	0 3,5	1 4
Aiguille ronde 1/2 cercle								
  	90 Vert			C2026730	C2026731	C2026732		
	75 Vert			C2026735		C2026733		
	8 x 75 V/B					M0027705		
Aiguille		Fil longueur cm couleur	USP métrique					
longueur mm	5/0 1		4/0 1,5	3/0 2	2/0 3	0 3,5	1 4	2 5
Aiguille ronde 1/2 cercle								
 	75 120 Vert		C0026014	C0026015 C0026002	C0026016	C0026017 C0026001	C0026018	
	75 90 Vert		C2026814	C2026738 C2026815	C2026739 C2026816	C2026817		
	75 90 Blanc				C2027839 C2027816	C2027817		
       	90 Blanc				C2027306			
	8 x 75 8 x 90 V/B				M0027713 M0027715			
	8 x 75 8 x 90 V/B				M0027716 M0027717			
	8 x 75 V/B				M0027766			

V/B = vert/blanc

# PremiCron®

Combinaison fil-aiguille













Aiguille longueur mm	Fil longueur cm couleur	USP métrique							
		3/0 2	2/0 3	2,5	0 3,5	1 4	2 5	3 6	5 7
Aiguille ronde 1/2 cercle									
 HR 26s 	75 Vert		C0026052			C0026051			
 HR 30 	75 Vert	C0026056	C0026057		C0026058	C0026059	C0026145		
 HR 37 	75 Vert		C0026036		C0026037	C0026038	C0026039		
 HR 37s 	75 Vert				C0026067	C0026068			
 HR 40 	75 Vert		C0026072					B0026425	

C Boîte de 36	B Boîte de 24	G Boîte de 12	M Boîte de 6
---------------	---------------	---------------	--------------

# PremiCron®

Combinaison fil-aiguille



Aiguille		Fil longueur cm couleur	USP métrique					
longueur mm	3/0 2		2/0 3	0 3,5	1 4	2 5	3 6	5 7
Aiguille ronde 1/2 cercle								
 <b>HR 48</b> 	75					C0026080	B0026182	
	Vert							
	75							B0027082
	Blanc							
Aiguille		Fil longueur cm couleur	USP métrique					
longueur mm	7/0 0,5		6/0 0,7	5/0 1	4/0 1,5	3/0 2	2/0 3	0 3,5
Aiguille ronde 3/8 cercle								
 <b>DR 12</b> 	45			C0026121				
	Vert							
 <b>2xDR 12</b> 	75		C2026852	C2026853	C2026854			
	Vert							
	75			C2027853	C2027854			
	Blanc							
 <b>DR 15</b> 	75				*C0026130	*C0026131		
	Vert							
 <b>DR 18</b> 	75				*C0026104	*C0026105		
	Vert							

\* Fabrication spéciale. Délai d'approvisionnement minimum : 8 à 12 semaines.

# PremiCron®

Combinaison fil-aiguille

















Aiguille		Fil	USP métrique						
			6/0 0,7	5/0 1	4/0 1,5	3/0 2	2/0 3	0 3,5	1 4
longueur mm		longueur cm couleur							
Aiguille ronde 3/8 cercle									
		Pledgets 6x3 mm durs	75 V/B					*M0027671	
	<b>2xDR 18</b> 	RCP	75 90 Vert			C2026864	C2026865 C2026858	*C2026883	
		Multi pack	8 x 90 V/B					M0027769	
	<b>DR 22</b> 		75 Vert				C0026226	C0026227	C0026228
	<b>2xDR 22</b> 	RCP	75 Vert				*C2026116		
	<b>DR 26</b> 		75 Vert				*C0026136	C0026137	
	<b>2xDR 26</b> 		90 Vert					C2026873	
	<b>DR 32</b> 		75 Vert				C0026141	C0026142	C0026238 *C0026239

\* Fabrication spéciale. Délai d'approvisionnement minimum : 8 à 12 semaines.

C Boîte de 36	B Boîte de 24	G Boîte de 12	M Boîte de 6
---------------	---------------	---------------	--------------

# PremiCron®

## Combinaison fil-aiguille

Aiguille		Fil	USP métrique						
longueur mm		longueur cm couleur	5/0 1	4/0 1.5	3/0 2	2/0 3	0 3.5	1 4	2 5
Aiguille ronde droite									
	<b>GR 19</b> 	75 Vert		C0026113					
Aiguille ronde micropointe 1/2 cercle									
	 Pledgets 3x3 mm souples	75 Vert					C2026560		
	 Pledgets 3x3 mm durs	90 Blanc					*C2027316		
	  Pledgets 3x3 mm durs	8 x 75 V/B					M0027738		
	  Pledgets 3x3 mm souples	4 x 75 V/B					*M0027824		
	  Pledgets 3x3 mm souples	8 x 75 V/B					*M0027819		
		75 Vert					C2026250		
		90 Vert	*C2026456	*C2026304					
		75 Blanc					C2027656		
		75 Vert					C2026563		
	 Pledgets 6x3 mm durs	90 Vert					*C2026308		
		8 x 75 V/B					M0027723		
	 8 x 75 V/B						M0027722		

V/B = vert/blanc

# PremiCron®

Combinaison fil-aiguille













Aiguille		Fil	USP métrique							
			5/0 1	4/0 1.5	3/0 2	2/0 3	0 3.5	1 4	2 5	
longueur mm		longueur cm couleur								
Aiguille ronde micropointe 1/2 cercle										
 	  Pledgets 6x3 mm durs	Multi pack	4 x 75 V/B				M0027628	M0027579		
		Multi pack	8 x 75 V/B				*M0027128			
		Multi pack	4 x 90 V/B					*M0027975		
	  Pledgets 6x3 mm souples	Multi pack	8 x 90 V/B				M0027863			
		Multi pack	4 x 75 V/B				*M0027813			
		Multi pack	8 x 75 V/B				M0027811			
 	  Pledgets 6x3 mm souples		75 Vert				*C2026585			
		Multi pack	8 x 75 V/B				*M0027102			
	  Pledgets 6x3 mm durs	Multi pack	8 x 75 V/B				*M0027100			
		Multi pack	4 x 90 V/B				M0027004			
	  Pledgets 6x3 mm durs		90 Vert				*C0026321			
 	  Pledgets 6x3 mm durs	Multi pack	4 x 90 V/B					*M0027619		

C Boîte de 36	B Boîte de 24	G Boîte de 12	M Boîte de 6
---------------	---------------	---------------	--------------

# PremiCron®

















## Combinaison fil-aiguille

Aiguille longueur mm	Fil longueur cm couleur	USP métrique							
		5/0 1	4/0 1.5	3/0 2	2/0 3	0 3.5	1 4	2 5	
Aiguille ronde micropointe 1/2 cercle									
 	75			C0026301	C0026302	C0026459			
	Vert								
 	75			*C2026215	*C2026316				
	90			C2026312		C2026419			
	Vert								
	 Pledgets 6x3 mm souples	75 cm				C2026594	C0026162		
	Vert								
	 Pledgets 6x3 mm souples	90					*C0026165		
	Vert								
 4 x 75 8 X 75 V/B					M0027371 M0027791				
  Pledgets 6x3 mm durs	4 X 75 8 x 75 8 x 90 V/B				M0027543 M0027792 M0027660				
 Pledgets 6x3 mm durs	75				C2026319				
Vert									
	75					C0026478		C0026216	
Vert									

# PremiCron®

Combinaison fil-aiguille











Aiguille longueur mm	Fil longueur cm couleur	USP métrique						
		6/0 0,7	5/0 1	4/0 1,5	3/0 2	2/0 3	0 3,5	1 4
Aiguille ronde micropointe 3/8 cercle								
  	 4 x 75 V/B					*M0027601		
	 8 x 75 V/B					*M0027311		
	 8 x 90 V/B					*M0027941		
	  4 x 75 V/B Pledgets 3x3 mm durs					*M0027600		
	  8 x 75 V/B Pledgets 3x3 mm durs					*M0027310		
	  8 x 90 V/B Pledgets 6x3 mm durs					*M0027519		
	  4 x 90 V/B Pledgets 6x3 mm souples					*M0027647		
	 8 x 75 V/B Pledgets 6x3 mm souples					*M0027312		
	 8 x 90 V/B Pledgets 6x3 mm souples					*M0027935		
  	75 Vert				C2026465	*C2026466		



# PremiCron®

Combinaison fil-aiguille 

Aiguille longueur mm	Fil longueur cm couleur	USP métrique						
		6/0 0,7	5/0 1	4/0 1,5	3/0 2	2/0 3	0 3,5	1 4
<b>Aiguille ronde micropointe 3/8 cercle</b>								
 <b>DRC 18</b> 	75 Vert			C0026364	C0026274			
<b>2xDRC 26</b> 	 Pledgets 6x3 mm durs	90 Vert				C0026410		

Aiguille longueur mm	Fil longueur cm couleur	USP métrique						
		6/0 0,7	5/0 1	4/0 1,5	3/0 2	2/0 3	0 3,5	1 4
<b>Aiguille ronde micropointe crochet</b>								
 <b>JRC 30s</b> 	75 Vert							C0026987
<b>Aiguille ronde micropointe composite</b>								
 <b>PRC 24</b> 	120 Vert					C0026102	C0026099	

V/B = vert/blanc

# PremiCron®

Combinaison fil-aiguille



Aiguille	Fil	USP métrique						
		6/0 0,7	5/0 1	4/0 1,5	3/0 2	2/0 3	0 3,5	1 4
Aiguille ronde pointe diamant 1/2 cercle								
  	90 Vert							
	75 Vert					C2026427		
	8 x 75 V/B			M0027798				
   	75							
	90					*C2026443		
	Vert							

\* Fabrication spéciale. Délai d'approvisionnement minimum : 8 à 12 semaines.

# PremiCron®



Combinaison fil-aiguille



# PremiCron®

Combinaison fil-aiguille



Aiguille	Fil	USP métrique						
		6/0	5/0	4/0	3/0	2/0	0	1
longueur mm	longueur cm couleur	0,7	1	1,5	2	3	3,5	4
Aiguille ronde pointe diamant 3/8 cercle								
  	90 Vert					*C2026491		
	8 x 90 V/B					M0027773		

C Boîte de 36	B Boîte de 24	G Boîte de 12	M Boîte de 6
---------------	---------------	---------------	--------------

# PremiCron®

Combinaison fil-aiguille



Aiguille	Fil	USP métrique						
		6/0	5/0	4/0	3/0	2/0	0	1
longueur mm	longueur cm couleur	0,7	1	1,5	2	3	3,5	4

## Aiguille triangulaire (tranchante sur l'extérieur) 1/2 cercle

	<b>HS 15</b> 	45 75 Vert			C0026197	C0026342		
	<b>HS 21</b> 	45 75 Vert			C0026199	C0026200 * C0026365	*C0026367	
	<b>HS 23</b> 	45 Vert				C0026202		

\* Fabrication spéciale. Délai d'approvisionnement minimum : 8 à 12 semaines.

# PremiCron®

Combinaison fil-aiguille



Aiguille longueur mm	Fil longueur cm couleur	USP métrique						
		4/0 1.5.7	3/0 2	2/0 3	0 3,5	1 4	2 5	3 6
Aiguille triangulaire (tranchante sur l'extérieur) 1/2 cercle								
HS 23ss 	75 Vert				*C0026403	C0026404	*C0026405	
HS 26 	75 Vert		C0026420	C0026421	C0026423			
HS 30 	75 Vert			C0026541	C0026542	C0026543	C0026544	B0026545
Aiguille longueur mm	Fil longueur cm couleur	USP métrique						
		3/0 2	2/0 3	0 3,5	1 4	2 5	3 6	5 7
Aiguille triangulaire (tranchante sur l'extérieur) 1/2 cercle								
HS 37 	75 Vert			C0026471	C0026472	C0026473		
HS 37s 	75 Vert			C0026467	C0026468	C0026469		

\* Fabrication spéciale. Délai d'approvisionnement minimum : 8 à 12 semaines.

C Boîte de 36	B Boîte de 24	G Boîte de 12	M Boîte de 6
---------------	---------------	---------------	--------------

# PremiCron®

Combinaison fil-aiguille



Aiguille longueur mm	Fil longueur cm couleur	USP métrique						
		3/0 2	2/0 3	0 3,5	1 4	2 5	3 6	5 7
<b>Aiguille triangulaire (tranchante sur l'extérieur) 1/2 cercle</b>								
HS 40	75 Vert				C0026479	*C0026480	B0026481	B0026482
HS 40s	75 Vert					C0026390		
HS 48	75 Vert				C0026375	B0026376	B0026377	B0026399
Aiguille longueur mm	Fil longueur cm couleur	USP métrique						
		6/0 0,7	5/0 1	4/0 1,5	3/0 2	2/0 3	0 3,5	1 4
<b>Aiguille triangulaire (tranchante sur l'extérieur) 3/8 cercle</b>								
DS 12	45 Vert	C0026171	C0026172	C0026173				
DS 16	45 75 Vert		C0026176	C0026177 C0026245				
DS 19	45 75 Vert			C0026552 C0026231	C0026553 C0026232	C0026554 C0026233		*C0026235
DS 24	75 Vert			C0026514	C0026515	C0026516	C0026517	C0026518

\* Fabrication spéciale. Délai d'approvisionnement minimum : 8 à 12 semaines.

V/B = vert/blanc

# PremiCron®

Combinaison fil-aiguille



Aiguille longueur mm	Fil longueur cm couleur	USP métrique						
		3/0 2	2/0 3	0 3,5	1 4	2 5	3 6	5 7

### Aiguille triangulaire (tranchante sur l'extérieur) 3/8 cercle

DS 30 	75 Vert		C0026531	C0026532	C0026533	C0026534		
DS 35 	75 Vert		*C0026281	C0026282	C0026283	C0026284		
DS 39 	75 Vert		C0026329	C0026330	C0026331	C0026332		
DS 48 	75 Vert					B0026355		

### Aiguille triangulaire (tranchante sur l'extérieur) droite

GS 51 	75 Vert	C0026505	C0026506	C0026507	C0026508	B0026509		
GS 60 	75 Vert		C0026315					
GS 65 	75 Vert		C0026287	C0026288	C0026289			

Aiguille longueur mm	Fil longueur cm couleur	USP métrique						
		6/0 0,7	5/0 1	4/0 1,5	3/0 2	2/0 3	0 3,5	1 4

### Aiguille triangulaire avec pointe de précision (tranchante sur l'extérieur) 3/8 cercle

2xDSMP 7 	45 Blanc	*C0027074						
2xDSMP 11 	45 Blanc		C0027031					

\* Fabrication spéciale. Délai d'approvisionnement minimum : 8 à 12 semaines.

C Boîte de 36	B Boîte de 24	G Boîte de 12	M Boîte de 6
---------------	---------------	---------------	--------------

# PremiCron®

Combinaison fil-aiguille



	Fil longueur cm	USP métrique								
		5/0 1	4/0 1,5	3/0 2	2/0 1	0 3,5	1 4	2 5	3 6	
<b>Sutures pré-coupées – Brins</b>										
10 fils de 45 cm	10 x 45 Vert		C0120006	C0120007	C0120008	B0120009	B0120010			
10 fils de 75 cm	10 x 75 Vert				C0120021					
	Fil longueur cm	USP métrique								
		5/0 1	4/0 1,5	3/0 2	2/0 1	0 3,5	1 4	2 5	3 6	
<b>Bobines</b>										
1 fil de 250 cm	250 Vert		G0120056	G0120060	G0120061	G0120062	G0120063	G0120064	G0120065	
	Fil longueur cm	USP métrique								
		4/0 1,5	3/0 2	2/0 3	0 3,5	1 4	2 5	3 6	5 7	
<b>Bobines</b>										
1 fil de 250 cm	250 Vert								G0120067	

## PremiPatch® PTFE pledget

Description du produit	Contenu par boîte	Référence
 Pledget Dur 3 x 3 x 1.5 mm	6	C0027996

V/B = vert/blanc

V/B = vert/blanc

C Boîte de 36	B Boîte de 24	G Boîte de 12	M Boîte de 6
---------------	---------------	---------------	--------------



# Dafilon®

Monofilament synthétique non résorbable de polyamide

## Description

Dafilon® est un monofilament non résorbable synthétique composé de polymères de Polyamide 6/6.6 (bleu), Polyamide 6.6 (noir) ou Polyamide 6 (incolore).

Dafilon® bleu et Dafilon® incolore sont indiqués pour la fermeture de plaies superficielles et la chirurgie plastique. Dafilon® bleu est également utilisé en neurochirurgie.

Dafilon® noir est utilisé pour les interventions ophtalmiques et microchirurgicales.

Comme toute suture de nylon, bien que non résorbable, une hydrolyse progressive de la suture peut se produire, entraînant une diminution de sa résistance dans le temps.

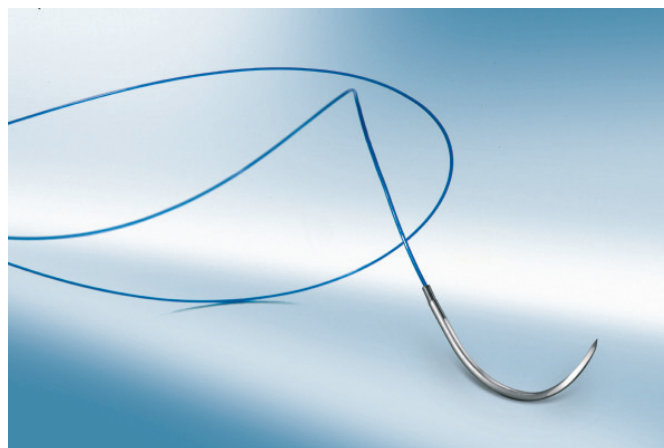

Dafilon®

## Indications

- Fermeture cutanée
- Microchirurgie
- Ophtalmologie
- Neurochirurgie

### Aperçu Produit :

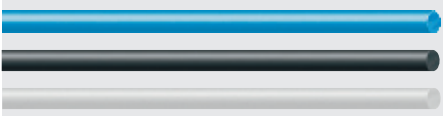
Structure	Monofilament 
Couleur	Bleu, noir ou incolore
Composition chimique	Polyamide
Enduction	Non enduit
Origine	Synthétique
Calibres	USP 11/0 (Déc. 0.1) à USP 5 (Déc. 7)
Résorption	Non résorbable
Stérilisation	Irradiation Gamma / Oxyde d'Éthylène (microchirurgie 7/0 à

# Dafilon®

Combinaison fil-aiguille



Aiguille			Fil	USP métrique								
angle	longueur mm	diamètre microns		longueur cm	11/0 0,1	10/0 0,2	9/0 0,3	8/0 0,4	7/0 0,5	6/0 0,7	5/0 1	4/0 1,5
Aiguille ronde de microchirurgie 1/2 cercle												
180°	<b>HRm 4</b> 	70 µ	8 Noir	*G1118374								
Aiguille ronde de microchirurgie 3/8 cercle												
135°	<b>DRm 3</b> 	50 µ	5 10 Noir	*G1118064 *G1118366								
135°	<b>DRm 4</b> 	70 µ	10 Noir	G1118080	G1118099							
135°	<b>DRm 4s</b> 	140 µ	10 Noir			G1118137						
135°	<b>DRm 5</b> 	100 µ	15 Noir		G1118110	G1111434						
135°	<b>DRm 6</b> 	140 µ	15 Noir			G1118161	G1118170					
Aiguille ronde de microchirurgie composite												
95/110°	<b>PRm 4</b> 	70 µ	8 Noir		*G1118463							
100/90°	<b>PRm 5</b> 	100 µ	13 Noir			*G1118471						
100/95°	<b>PRm 6</b> 	140 µ	15 Noir				*G1118390					
Aiguille ronde micropointe de microchirurgie 3/8 cercle												
135°	<b>DRCm 3</b> 	100 µ	15 Noir		G1118048							

\* Fabrication spéciale. Délai d'approvisionnement minimum : 8 à 12 semaines.

C Boîte de 36	B Boîte de 24	G Boîte de 12	M Boîte de 6
---------------	---------------	---------------	--------------

# Dafilon®

Combinaison fil-aiguille



Aiguille			Fil	USP métrique							
angle	longueur mm	diamètre microns	longueur cm couleur	11/0 0,1	10/0 0,2	9/0 0,3	8/0 0,4	7/0 0,5	6/0 0,7	5/0 1	4/0 1,5
135°	<b>2xDRCm 4</b> 	140 µ	15 Noir		*G1118404						
135°	<b>DRCm 5</b> 	100 µ	15 Noir			*G1111140					
135°	<b>2xDRCm 6</b> 	140 µ	15 Noir				*G1118455				
Aiguille ronde micropointe de microchirurgie composite											
100/95°	<b>PRCm 5</b> 	100 µ	8 13 Noir		*G1118412	*G1118420					



\* Fabrication spéciale. Délai d'approvisionnement minimum : 8 à 12 semaines.

Aiguille			Fil	USP métrique							
angle	longueur mm	diamètre microns	longueur cm couleur	11/0 0,1	10/0 0,2	9/0 0,3	8/0 0,4	7/0 0,5	6/0 0,7	5/0 1	4/0 1,5
Aiguille spatulée de microchirurgie 3/8 cercle											
140°	<b>DLm 6</b> 	150 µ	7 15 30 Noir			*G1118331 G1118722 G1118749		*G1118730 *G1118757			
140°	<b>2xDLm 6</b> 	150 µ	30 Noir			G1118706	G1118714				
137°	<b>DLm 6s</b> 	200 µ	15 30 45 Noir			G1118781	*G1118790	*G1118579 *G1110250 *G1118854			
137°	<b>2xDLm 6s</b> 	200 µ	30 Noir			G1118765	G1118773				
Aiguille spatulée de microchirurgie 1/4 cercle											
97°	<b>2xVLm 6s</b> 	200 µ	30 Noir				*G1111337				
97°	<b>2xVLm 8</b> 	200 µ	45 Noir							*C0938106	

# Dafilon®

Combinaison fil-aiguille **Easyslide**

Aiguille longueur mm	Fil longueur cm couleur	USP métrique								
		6/0 0,7	5/0 1	4/0 1,5	3/0 2	2/0 3	0 3,5	1 4	2 5	
Aiguille ronde 1/2 cercle										
	100 Bleu								B0930628	

Aiguille longueur mm	Fil longueur cm couleur	USP métrique								
		6/0 0,7	5/0 1	4/0 1,5	3/0 2	2/0 3	0 3,5	1 4	2 5	
Aiguille triangulaire droite										
	90 Bleu			*C0935590	C0935603	C0935611 G0935611	*C0935565	C0935573		
	75 90 Bleu				C0932655 C0934658	C0932663 C0934690	C0934691			

\* Fabrication spéciale. Délai d'approvisionnement minimum : 8 à 12 semaines.

Aiguille longueur mm	Fil longueur cm couleur	USP métrique								
		6/0 0,7	5/0 1	4/0 1,5	3/0 2	2/0 3	0 3,5	1 4	2 5	
Aiguille ronde droite										
	75 90 Bleu					C0938505	B0932730			

C Boîte de 36









B Boîte de 24

G Boîte de 12

M Boîte de 6

# Dafilon®

Combinaison fil-aiguille 







Aiguille longueur mm	Fil longueur cm couleur	USP métrique								
		6/0 0,7	5/0 1	4/0 1,5	3/0 2	2/0 3	0 3,5	1 4	2 5	
Aiguille triangulaire (tranchante sur l'extérieur) 1/2 cercle										
	75 Bleu		*C0936593	C0932507						
	75 90 Bleu			C0932876	C0932884		*C0932873			
	75 90 Bleu			*C0935948	*C0935963 C0932957		*C0934968			
	75 90 Bleu				*C0935000 C0934003	C0934011			*C0934038	
	90 Bleu					C0934054			C0934046	
							*C0932760			
	75 90 Bleu								C0932604	*B0933159
Aiguille longueur mm	Fil longueur cm couleur	USP métrique								
		6/0 0,7	5/0 1	4/0 1,5	3/0 2	2/0 3	0 3,5	1 4	2 5	
Aiguille ronde 3/8 cercle										
	75 Bleu					*C0935296				

\* Fabrication spéciale. Délai d'approvisionnement minimum : 8 à 12 semaines.

C Boîte de 36	B Boîte de 24	G Boîte de 12	M Boîte de 6
---------------	---------------	---------------	--------------

# Dafilon®

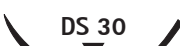
Combinaison fil-aiguille 

Aiguille longueur mm	Fil longueur cm couleur	USP métrique							
		6/0 0,7	5/0 1	4/0 1,5	3/0 2	2/0 3	0 3,5	1 4	2 5
Aiguille triangulaire (tranchante sur l'extérieur) 3/8 cercle									
DS 12 	60 Bleu	C0935042	C0935050	*C0935069					
DS 16 	75 Bleu	C0935115	C0935123 G0935123	C0935131	C0935107				
DS 19 	75 90 Bleu		G0935190 C0935255	C0935220	C0935239	C0935247			
DS 24 	45 90 120 Bleu		*C0932317	C0935310	C0935328 G0935328	C0935336	*C0935387		
DS 30 	75 90 Bleu			*C0932450	C0934410	C0935522	*C0934391	*C0934429	
DS 35 	90 Bleu				C0934780	C0934801	C0934810	*C0934836	
DS 39 	90 Bleu					C0934569	C0934573	C0934577	*B0934579

\* Fabrication spéciale. Délai d'approvisionnement minimum : 8 à 12 semaines.

# Dafilon®

Combinaison fil-aiguille



Aiguille	Fil	USP métrique							
		8/0 0,4	7/0 0,5	6/0 0,7	5/0 1	4/0 1,5	3/0 2	2/0 3	0 3,5
Aiguille triangulaire avec pointe de précision (tranchante sur l'extérieur) 3/8 cercle									
<b>DSMP 11</b> 	45 Bleu			C0936022	C0936014				
	Boucle								
<b>DSMP 13</b> 	45 Bleu			C0936081	C0936090	C0936103			
	45 Incolore			C0916081					
<b>DSMP 16</b> 	45 Bleu			C0936146	C0936154	C0936162			
	45 Incolore				*C0916143	*C0916144			

Aiguille	Fil	USP métrique							
		8/0 0,4	7/0 0,5	6/0 0,7	5/0 1	4/0 1,5	3/0 2	2/0 3	0 3,5
Aiguille triangulaire avec pointe de précision (tranchante sur l'extérieur) 3/8 cercle									
<b>DSMP 19</b> 	45 75 Bleu				C0936227	C0936235 C0936731	C0936243 C0936740		
	75 Incolore					*C0916054	*C0916055		
<b>DSMP 24</b> 	75 Bleu						C0936812	C0936820	
	75 Incolore						*C0916065		

\* Fabrication spéciale. Délai d'approvisionnement minimum : 8 à 12 semaines.

C Boîte de 36	B Boîte de 24	G Boîte de 12	M Boîte de 6
---------------	---------------	---------------	--------------

# Dafilon®

Combinaison fil-aiguille 

	Fil longueur cm couleur	USP métrique							
		4/0 1,5	3/0 2	2/0 3	0 3,5	1 4	2 5	3 6	5 7
Sutures pré-coupées – Brins									
<b>6 fils de 45 cm</b>	6 x 45 Bleu	*B0436532	B0436533	B0436534	*B0436535	B0436536	B0436537	B0436538	*B0436540
<b>6 fils de 60 cm</b>	6 x 60 Bleu			B0436500			*B0436503	*B0436504	

\* Fabrication spéciale. Délai d'approvisionnement minimum : 8 à 12 semaines.



# Dagrofil®

Tresse synthétique non résorbable de polyester

## Description

Dagrofil® est une tresse synthétique non résorbable, non enduite, de polyester, disponible en vert ou blanc.

## Indications

- Toutes pratiques chirurgicales nécessitant une suture non résorbable

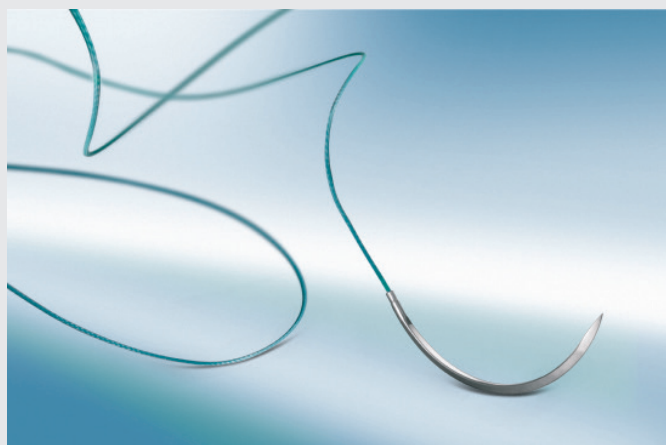

### Aperçu Produit :

Structure

Tresse

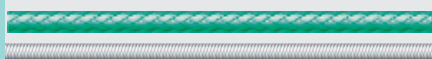

Couleur

Vert ou blanc

Composition chimique

Polyester

Enduction

Non enduit

Origine

Synthétique

Calibres

USP 6/0 (Déc. 0,7)  
à USP 5 (Déc. 1)

Résorption

Non résorbable







Stérilisation

Irradiation Gamma

# Dagrofil®

Combinaison fil-aiguille













Aiguille longueur mm	Fil longueur cm couleur	USP métrique									
		6/0 0,7	5/0 1	4/0 1,5	3/0 2	2/0 3	0 3,5	1 4	2 5	3 6	
Aiguille ronde 1/2 cercle											
 HR 22	75 Vert			C0840297	C0840300	C0840319					
 HR 26	75 Vert				C0840416	C0840424	C0840432	C0840491			
 HR 30	75 Vert				C0840467	C0840475	C0840483	C0840556	*C0840440		
 HR 37	75 Vert						C0840521	C0840530			
Aiguille ronde 3/8 cercle											
 2xDR 12	45 Vert			*C0858188							
 DR 32	75 Vert					C0841587	C0841595	C0841609			

\* Fabrication spéciale. Délai d'approvisionnement minimum : 8 à 12 semaines.



# Dagrofil®

## Combinaison fil-aiguille

Aiguille longueur mm	Fil longueur cm couleur	USP métrique							
		6/0 0.7	5/0 1	4/0 1.5	3/0 2	2/0 3	0 3.5	1 4	2 5
Aiguille triangulaire (tranchante sur l'extérieur) 1/2 cercle									
	45 Vert				C0844149				
	90 Vert					C0849350			
Aiguille triangulaire (tranchante sur l'extérieur) 1/2 cercle									
	75 Vert				*C0842303				
	75 Vert					C0842427			
	75 Vert						*C0842249	C0842257	C0842265
	75 Vert							C0842281	
Aiguille longueur mm	Fil longueur cm couleur	USP métrique							
		5/0 1	4/0 1.5	3/0 2	2/0 3	0 3.5	1 4	2 5	3 6
	75 Vert								*B0842648
Aiguille triangulaire (tranchante sur l'extérieur) 3/8 cercle									
	45 Blanc		C0858056						
	45 Vert	C0842125							
	75 Vert		C0845198						
	45 Vert	C0842192	C0842206	C0842214	*C0842222				

# Dagrofil®

## Combinaison fil-aiguille

Aiguille longueur mm	Fil longueur cm couleur	USP métrique								
		6/0 0,7	5/0 1	4/0 1,5	3/0 2	2/0 3	0 3,5	1 4	2 5	3 6
Aiguille triangulaire (tranchante sur l'extérieur) 3/8 cercle										
 DS 24	75 Vert					C0842362				
 DS 30	75 Vert					C0842478	C0842486	C0842494		
 DS 39	75 Vert						C0842583	C0842591		
Aiguille longueur mm	Fil longueur cm couleur	USP métrique								
		5/0 1	4/0 1,5	3/0 2	2/0 3	0 3,5	1 4	2 5	3 6	4 6
Bobines										
1 fil de 250 cm	1 x 250 Vert				G0341231	G0341240	G0341258	G0341266	G0341274	

## Tresse naturelle non résorbable de soie

### Description

Silkam® est une tresse non résorbable, enduite, composée de filaments de soie naturelle. Silkam® est indiquée pour les applications où la pratique chirurgicale nécessite l'emploi de sutures non résorbables. Silkam® est disponible en noir.

### Indications

- Toutes pratiques chirurgicales nécessitant un support non résorbable

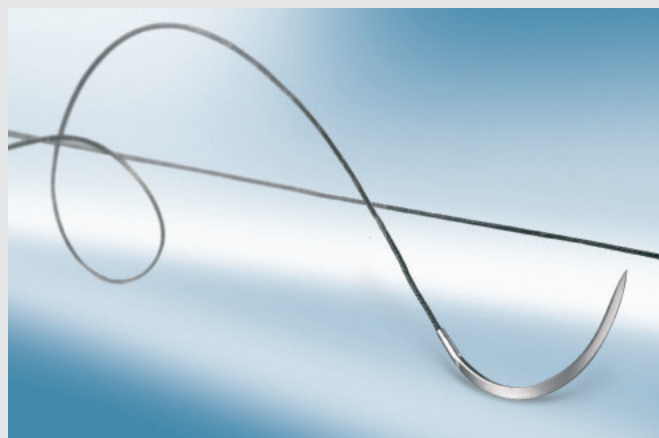



### Aperçu Produit :

Structure	Tresse
Couleur	Noire
Composition chimique	Filaments naturels de soie
Enduction	Cire raffinée de paraffine
Origine	Cocons de vers à soie
Calibres	USP 8/0 (Déc. 0,4) à USP 5 (Déc. 1)
Résorption	Non résorbable
Stérilisation	Irradiation Gamma









# Silkam®

Combinaison fil-aiguille 





Aiguille longueur mm	Fil longueur cm couleur	USP métrique							
		6/0 0,7	5/0 1	4/0 1,5	3/0 2	2/0 3	0 3,5	1 4	2 5
Aiguille ronde 1/2 cercle									
 HR 17	75 Noir		*C0760129	C0760137	C0760145	C0760153			
 HR 26	75 Noir			C0760404	C0760412	C0760420	C0760439	C0760447	
 HR 30	75 Noir				C0760463	C0760471	C0760480	C0760498	

\* Fabrication spéciale. Délai d'approvisionnement minimum : 8 à 12 semaines.









C Boîte de 36	B Boîte de 24	G Boîte de 12	M Boîte de 6
---------------	---------------	---------------	--------------

Aiguille longueur mm	Fil longueur cm couleur	USP métrique							
		7/0 0,5	6/0 0,7	5/0 1	4/0 1,5	3/0 2	2/0 3	0 3,5	1 4
<b>Aiguille ronde 3/8 cercle</b>									
<b>DR 12</b> 	45 75 Noir		C0761060 C0765295	C0765309	C0765317	C0765325			
<b>2xDR 12</b> 	45 75 Noir					C0769240 C0769193			
<b>DR 15</b> 	75 Noir				C0765767		*C0761150		
<b>DR 22</b> 	75 Noir					C0761311	C0761273		
<b>DR 32</b> 	75 Noir						C0761478	C0761476	*C0761494
<b>Aiguille triangulaire (tranchante sur l'extérieur) 1/2 cercle</b>									
<b>HS 18</b> 	75 Noir				G0762563	*C0762547			
<b>HS 21</b> 	75 Noir				C0764825	C0764248	C0764175		
<b>HS 26</b> 	75 Noir					C0762415	C0762423		
<b>HS 30</b> 	75 Noir					C0764612	C0764779	C0764620	

\* Fabrication spéciale. Délai d'approvisionnement minimum : 8 à 12 semaines.

Aiguille longueur mm	Fil longueur cm couleur	USP métrique							
		6/0 0,7	5/0 1	4/0 1,5	3/0 2	2/0 3	0 3,5	1 4	2 5
<b>Aiguille triangulaire droite</b>									
<b>GS 51</b> 	75 Noir			C0764655	C0762741	C0762750	C0762760	C0762768	
<b>GS 60</b> 	75 Noir				C0762652	C0762660	C0762679	C0764690	
Aiguille longueur mm	Fil longueur cm couleur	USP métrique							
		8/0 0,4	7/0 0,5	6/0 0,7	5/0 1	4/0 1,5	3/0 2	2/0 3	0 3,5
<b>Aiguille triangulaire pointe de précision (tranchante sur l'extérieur) 3/8 cercle</b>									
<b>2xDSMP 7</b> 	45 Noir		C0768073	C0768065					
<b>DSMP 19</b> 	45 Noir				*C0766704	*C0766682	*C0766690		



Aiguille longueur mm	Fil longueur cm couleur	USP métrique									
		8/0 0,4	7/0 0,5	6/0 0,7	5/0 1	4/0 1,5	3/0 2	2,5	2/0 3	0 3,5	
Aiguille triangulaire (tranchante sur l'extérieur) 3/8 cercle											
<b>DS 12</b> 	45				C0762067	C0762075	C0762083				
	75 Noir				C0765066	C0765074	C0765082	*C0765597			
<b>2xDS 12</b> 	45				C0768464	C0768472					
	75 Noir										
<b>DS 16</b> 	75				C0764060	C0764124	C0764132	C0764140	*C0764167	C0764159	
	75 Noir										
<b>2xDS 16</b> 	45							C0767840			
	75 Noir									C0767158	
Aiguille longueur mm	Fil longueur cm couleur	USP métrique									
		6/0 0,7	5/0 1	4/0 1,5	3/0 2	2,5	2/0 3	0 3,5	1 4	2 5	
Aiguille triangulaire (tranchante sur l'extérieur) 3/8 cercle											
<b>DS 19</b> 	75				C0765198	C0765201	C0765210		C0765228		
	75 Noir										
<b>DS 24</b> 	75					C0762350	C0762334	C0762369			
	75 Noir										
<b>DS 30</b> 	75					C0762466		C0762474	C0762482	C0762490	C0762504
	75 Noir										
<b>DS 35</b> 	75							C0772429	C0772437	C0764183	
	75 Noir										

\* Fabrication spéciale. Délai d'approvisionnement minimum : 8 à 12 semaines.

	Fil longueur cm couleur	USP métrique								
		3/0 2	2/0 3	0 3,5	1 4	2 5	3 6	5 7	6 8	
<b>Sutures pré-coupées – Brins</b>										
<b>10 fils de 75 cm</b>	10 x 75 Noir	C0264652	C0264660	B0264679	B0264695					

	Fil longueur cm couleur	USP métrique								
		4/0 1,5	3/0 2	2/0 3	0 3,5	1 4	2 5	3 6	4 6	5 7
<b>Bobines</b>										
<b>1 fil de 250 cm</b>	250 Noir	G0260410	G0260428	G0260436	G0260444	G0260452	G0260460	G0260479	*G0260410	G0260487

# Steelex®

## Monofilament non résorbable d'acier inoxydable

### Description

Steelex® est un monofilament synthétique non résorbable composé d'acier inoxydable, destiné à la chirurgie orthopédique. Steelex® est le matériau de base pour des produits comme le Sternum Set et l'Electrode Set.

### Indication

- Orthopédie

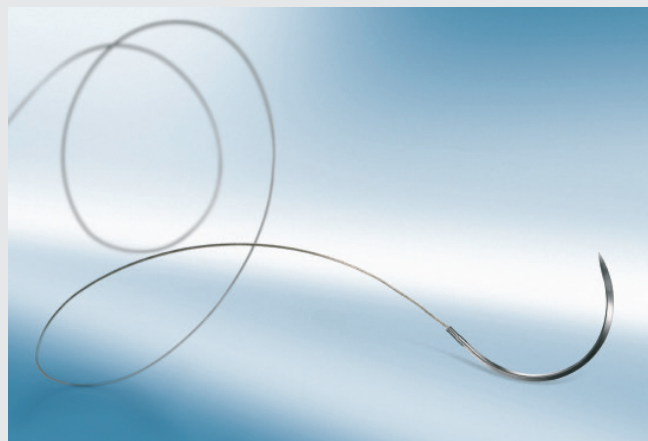



### Aperçu Produit :

Structure	Monofilament ou Câble
Couleur	Métallique
Composition chimique	Acier inoxydable
Enduction	Non enduit
Origine	Métal
Calibres	USP 5/0 (Déc. 1) à USP 7 (Déc. 0,5)
Résorption	Non résorbable
Stérilisation	Irradiation Gamma

# Steelex®

Combinaison fil-aiguille

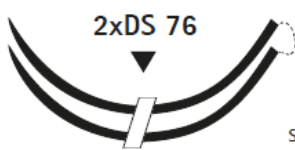

Aiguille	Fil	USP métrique							
		5/0 1	4/0 1,5	3/0 2	2/0 3	0 3,5	1 4	2 5	3 6
longueur mm	longueur cm								
Aiguille triangulaire (tranchante sur l'extérieur) 3/8 cercle									
 DS 19	75 Monofilament		*G0595209	*G00595217					
 DS 24	45 Torsade		G0612340	G0612359					
	75 Monofilament			*G0594350					
 DS 30	45 Torsade								
	75 Monofilament				*G0592471				
Aiguille	Fil	USP métrique							
longueur mm	longueur cm	2/0 3	0 0,5	1 4	2 5	3 6	4 6	5 7	6 8
Aiguille triangulaire (tranchante sur l'extérieur) 3/8 cercle									
 2xDS 76 <small>Sow</small>									*G00599506

\* Fabrication spéciale. Délai d'approvisionnement minimum : 8 à 12 semaines.

# Steelex®

Combinaison fil-aiguille



	Fil longueur cm	USP métrique							
		3/0 2	2/0 3	0 3,5	1 4	2 5	3 6	4 6	5 7
Sutures pré-coupées – Brins									
6 fils de 45 cm <small>LongPack</small>	6 x 45 Monofilament	*G0098442	G0098469	G0098477	G0098485	G0098493	G0098507		G0098515
	Fil longueur cm	USP métrique							
		0 3,5	1 4	2 5	3 6	4 6	5 7	6 8	7 9
Sutures pré-coupées – Brins									
6 fils de 45 cm <small>LongPack</small>	6 x 45 Monofilament							G0098523	G0098531

\* Fabrication spéciale. Délai d'approvisionnement minimum : 8 à 12 semaines.



# Sets de Sutures

---

Surgical Loop - Lacs suspenseurs

---

Steelex® Electrode-Set

---





# Surgical Loop

Pour la suspension des organes en per-opérateur

## Description

Les Surgical Loop sont des bandelettes de silicone radio-opaque, de coton. Les lacs suspenseurs sont utilisés pour la ligature, la séparation, le marquage, le support et la rétraction per-opérateur d'organes, vaisseaux sanguins, tendons et nerfs.

## Indications

Les Surgical Loop sont utilisés :

- Pour la ligature et le support mécanique des organes.
- Pour la séparation et la ligature des vaisseaux sanguins, tendons et nerfs.
- Pour le repérage des tissus.







## Aperçu Produit :

Structure	Tube, bandelette tressée 
Composition chimique	Blanc, bleu, vert, jaune, rouge, violet Silicone, coton
Enduction	Silicone (non enduit), Coton (enduit)
Origine	Synthétique, naturelle
Calibres	1.5 - 2.5 mm (silicone) 4 - 8 mm (coton)
Résorption	Non résorbable
Stérilisation	Oxyde d'Éthylène





# Surgical Loop

## Pour la suspension des organes en per-opératoire

Tube plein (excepté pour le lac serti qui est creux) en silicone radio-opaque

Diamètre	Longueur	Unités par boîte	Couleur / code			
						
1,5 mm	2 x 45 cm	24	B1095048	B1095021	B1095030	B1095013
1,5 mm	75 cm	24	B1095242	B1095226	B1095234	B1095218
2,5 mm	2 x 45 cm	24	B1095145	B1095129	B1095137	B1095110
2,5 mm	75 cm	24	B1095544	B1095528	B1095536	B1095510

Bandelette tressée en coton

Largeur	Longueur	Unités par boîte	Couleur / code			
						
4 mm	75 cm	24	B1095641	B1095633	B1095625	B1095650
8 mm	75 cm	24		B1095676	B1095668	

# Steelex<sup>®</sup> Electrode-Set

Pour le contrôle et le traitement des arythmies

## Description

L'Electrode Set est une électrode myocardique monopolaire temporaire utilisée pour le traitement des arythmies survenant en post-opératoire lors de chirurgie cardiaque. Il est composé d'un fil d'acier inoxydable câblé, partiellement gainé de polyéthylène bleu.

## Indications

Traitement des arythmies cardiaques survenant après la chirurgie cardiaque en association avec un pacemaker externe.

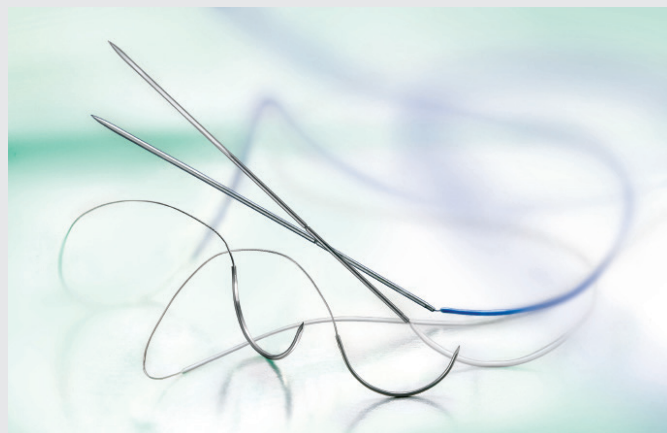

### Aperçu Produit :

Structure

Câble partiellement gainé

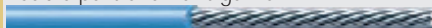

Composition chimique

Acier inoxydable

Enduction

Gaine de polyéthylène

Origine

Métal

Calibres

USP 3/0 (Déc. 2) à USP 0 (Déc. 3.5)

Résorption

Non résorbable

Stérilisation

Oxyde d'Ethylène

# Steelex® Electrode-Set

Pour le contrôle et le traitement des arythmies

Aiguille longueur mm	Fil longueur cm (couleur)	USP métrique						
		6/0 0,7	5/0 1	4/0 1,5	3/0 2	2/0 3	0 3,5	1 4
Aiguille ronde 1/2 cercle								
	60 Bleu					C0992054		
	60 Bleu					C0992038		
	60 Bleu					C0992046	C0992097	C0992100
	60 Bleu					C0992062		
	60 Bleu					C0992070		

C Boîte de 36

B Boîte de 24

G Boîte de 12

M Boîte de 6



Le présent document, son contenu, et notamment les données institutionnelles, les informations, les marques citées appartiennent à leurs titulaires respectifs qui y sont mentionnés. Toute représentation et/ou reproduction, partielle ou totale, de ce document et de son contenu, sans l'accord exprès et préalable de B. Braun, est strictement interdite et constitue une infraction aux droits de propriété intellectuelle de B. Braun.

Document et photo non contractuels. Document réservé à l'usage des professionnels de santé hospitaliers.

Fabriqués par : B. BRAUN Surgical SA – Carretera de Terrassa, 121 – 08191 Rubi (Barcelone) – Espagne

Distribué par : B. Braun Medical | 26 rue Armengaud | 92210 Saint-Cloud | France  
Tél. 01 41 10 53 00 | Fax 01 70 83 45 00 | [www.bbraun.fr](http://www.bbraun.fr) |  
SAS au capital de 31 000 000 € | RCS Nanterre 562050856

Edition 06.2021

SUT\_20210613